

GRADE 1

TERM 1 2021

**ENGLISH
FIRST ADDITIONAL
LANGUAGE**

RESOURCE PACK

WEEKS

3&4

We go to
school

happy

sad

today

backpack

bag

carry

school

favourite

draw

listen

story

excited

friend

teacher

dog

read

write

sing

scared

first

uniform

shoes

pencil

pen

book

learn

teach

maths

letters

taxi

bus

drive

walk

desk

sit

front

back

all

day

at

school

I

like

to

play

classroom

stationery

I feel . . .

I like . . .

WEEKS

5&6

My family

rope

skip

game

climb

backyard

dirty

clean

help

wait

friend

baby

sister

brother

home

family

small

big

little

big

born

new

younger

older

sibling

doll

hold

held

wrap

blanket

nappy

neck

strong

weak

Mom

dad

and

my

have

a

big

family

a

ant

apple

axe

grandparents

grandfather

grandmother

My family

is . . .

WEEKS

7 & 8

We play
outside

ball

kick

throw

bounce

hot

cold

outside

inside

slide

swings

down

run

pond

swim

jump

tree

sun

shade

sit

season

Summer

Winter

Spring

flowers

leaves

grow

bucket

splash

dry

wet

do

you

hot

run

t

tap

tiger

we

in

the

sun

s

snake

snail

sand

sun

playground

temperature

I like

to . . .

I like to

play . . .

WEEKS

9 & 10

**We have
feelings**

sad

mad

feeling

late

miss

bus

grumpy

mood

silly

bad

good

wear

uniform

wrong

mistake

forget

bag

calm

excited

scared

love

hate

confused

shorten

annoyed

long

short

polite

rude

worried

quickly

slowly

wait

syllable

name

clap

count

is

so

happy

she

p

pap

pencil

am

sad

he

said

t

tap

tiger

embarrassed

swimming costume

corrected (verb)

I felt grumpy
when . . .

I felt scared

when . . .

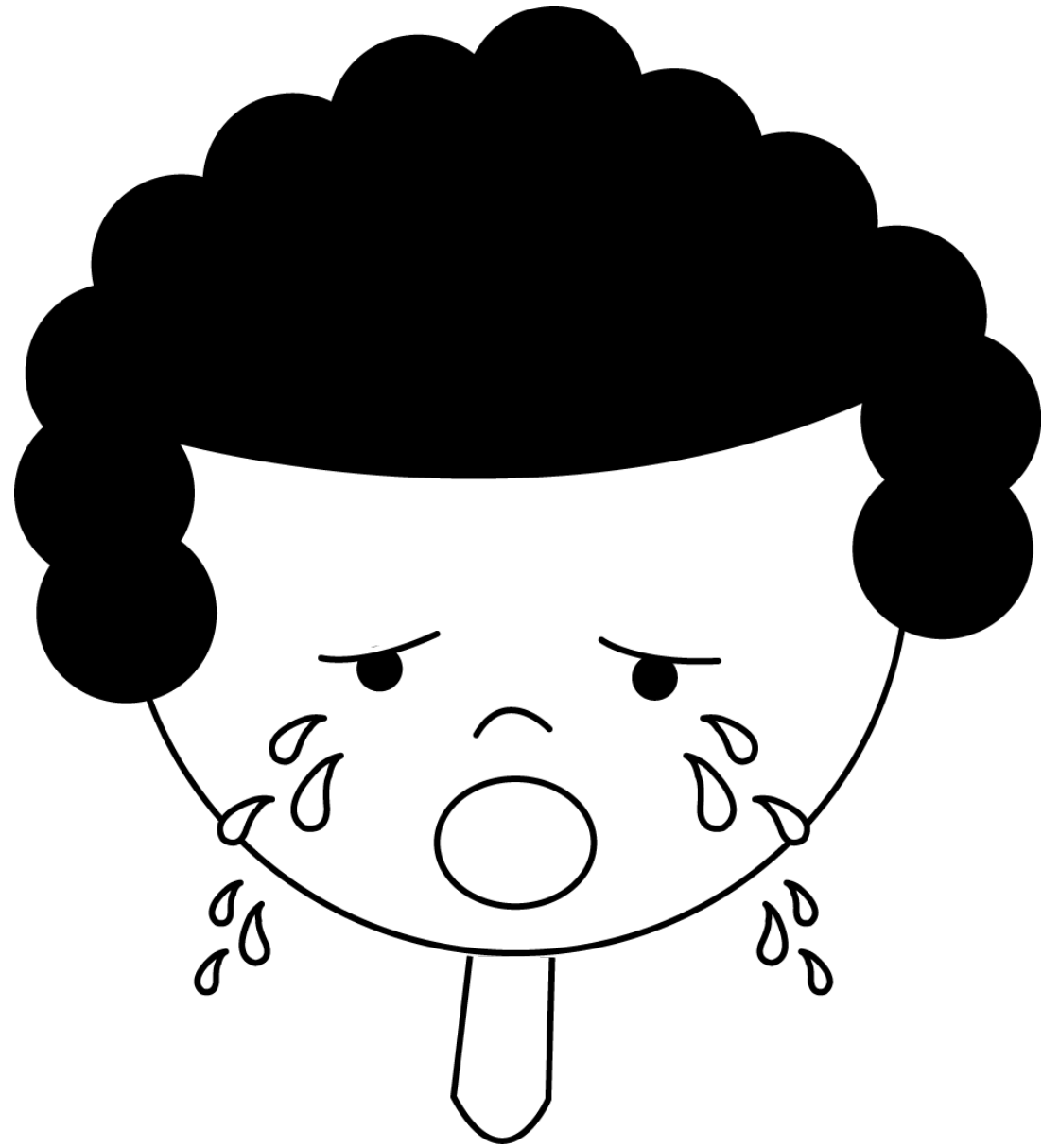

sad

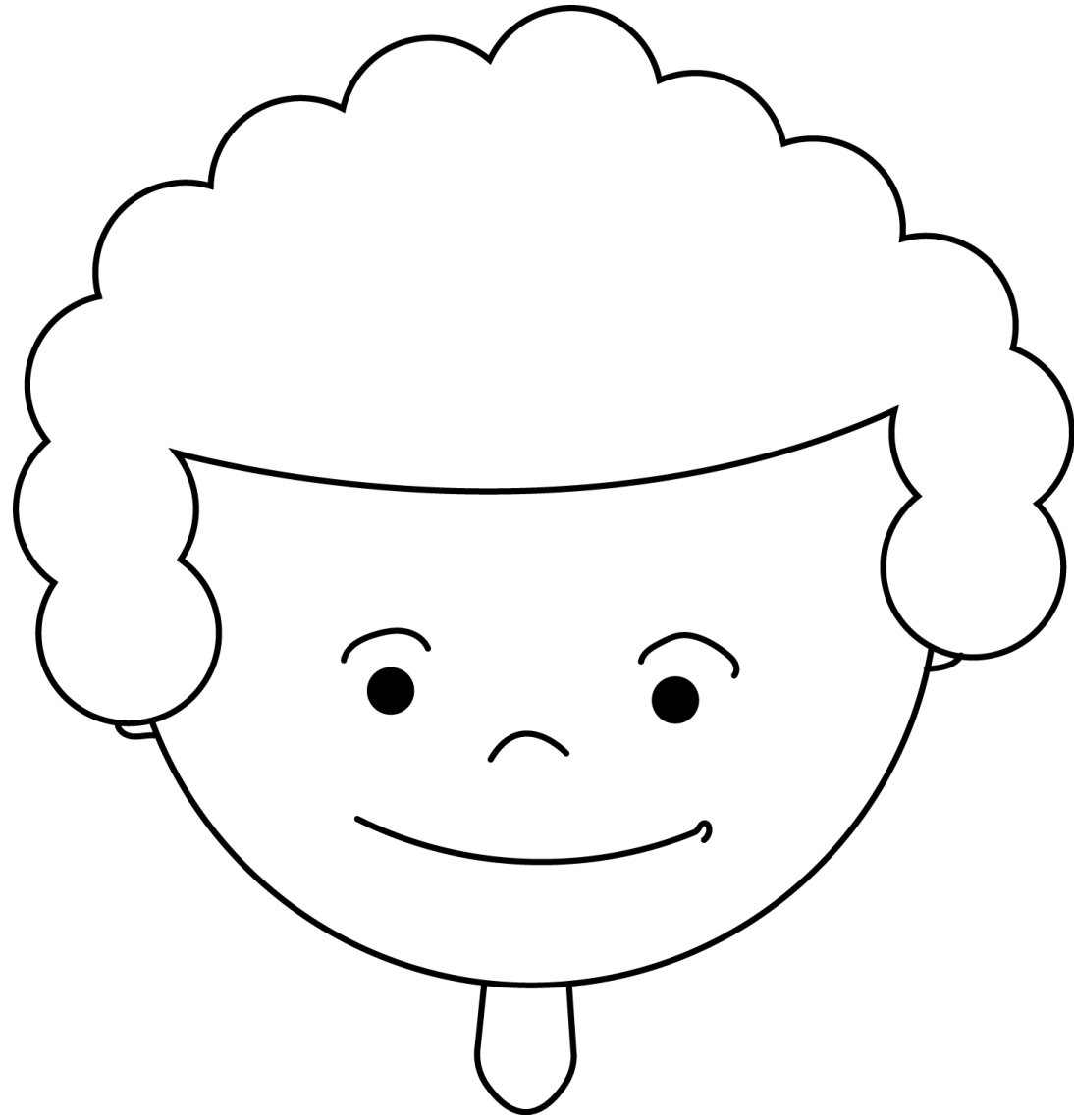

happy

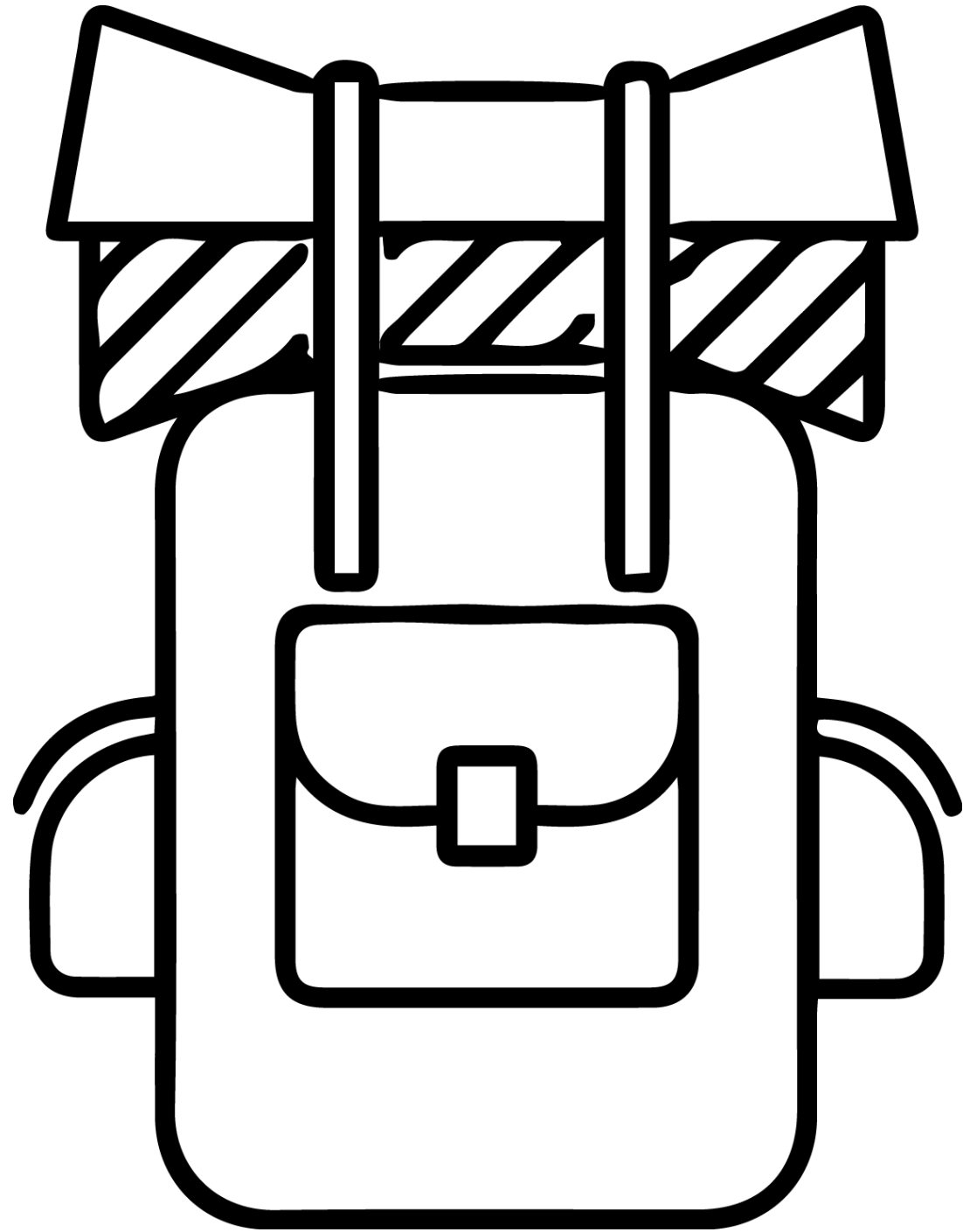

backpack

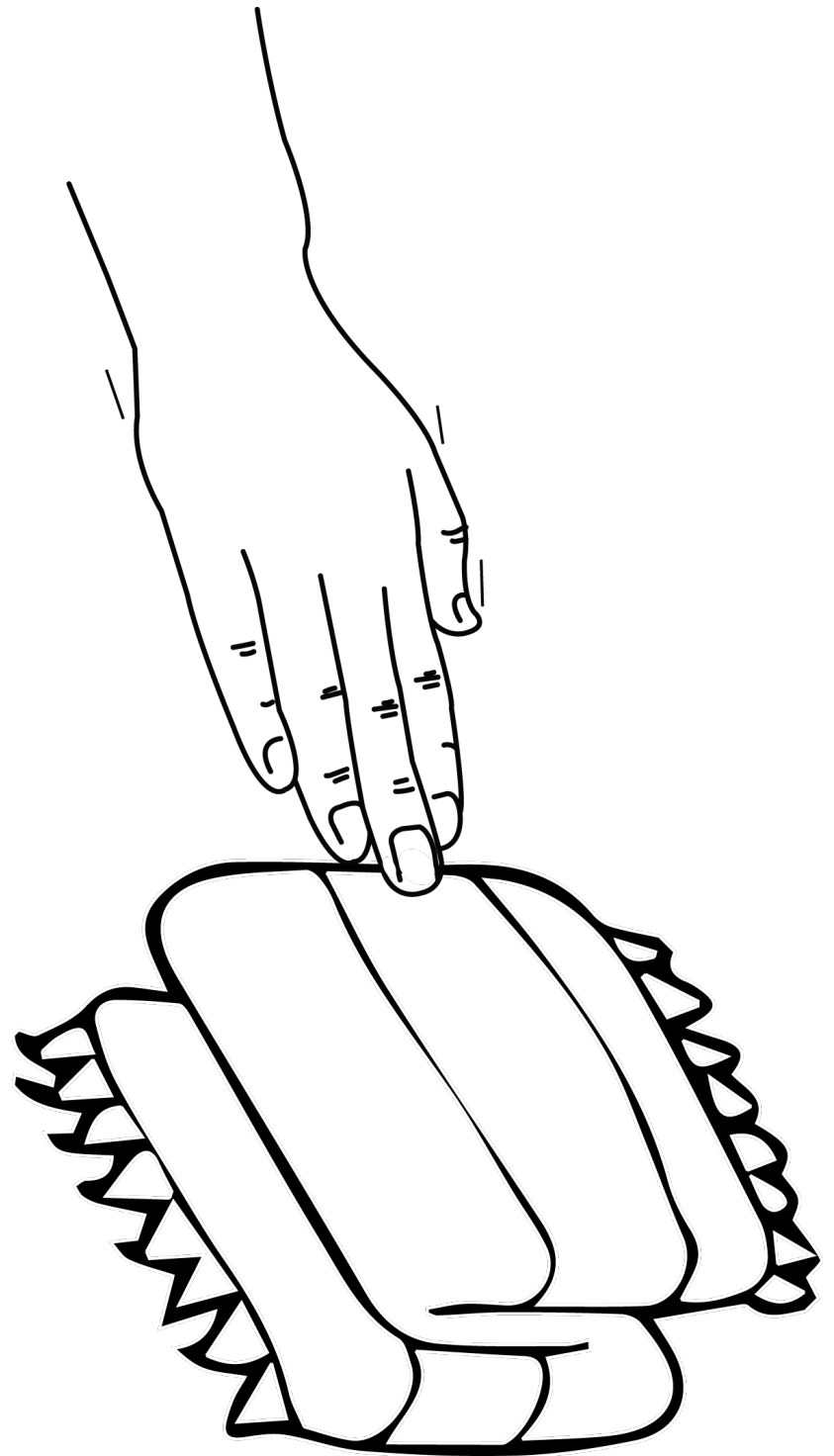

feel



carry

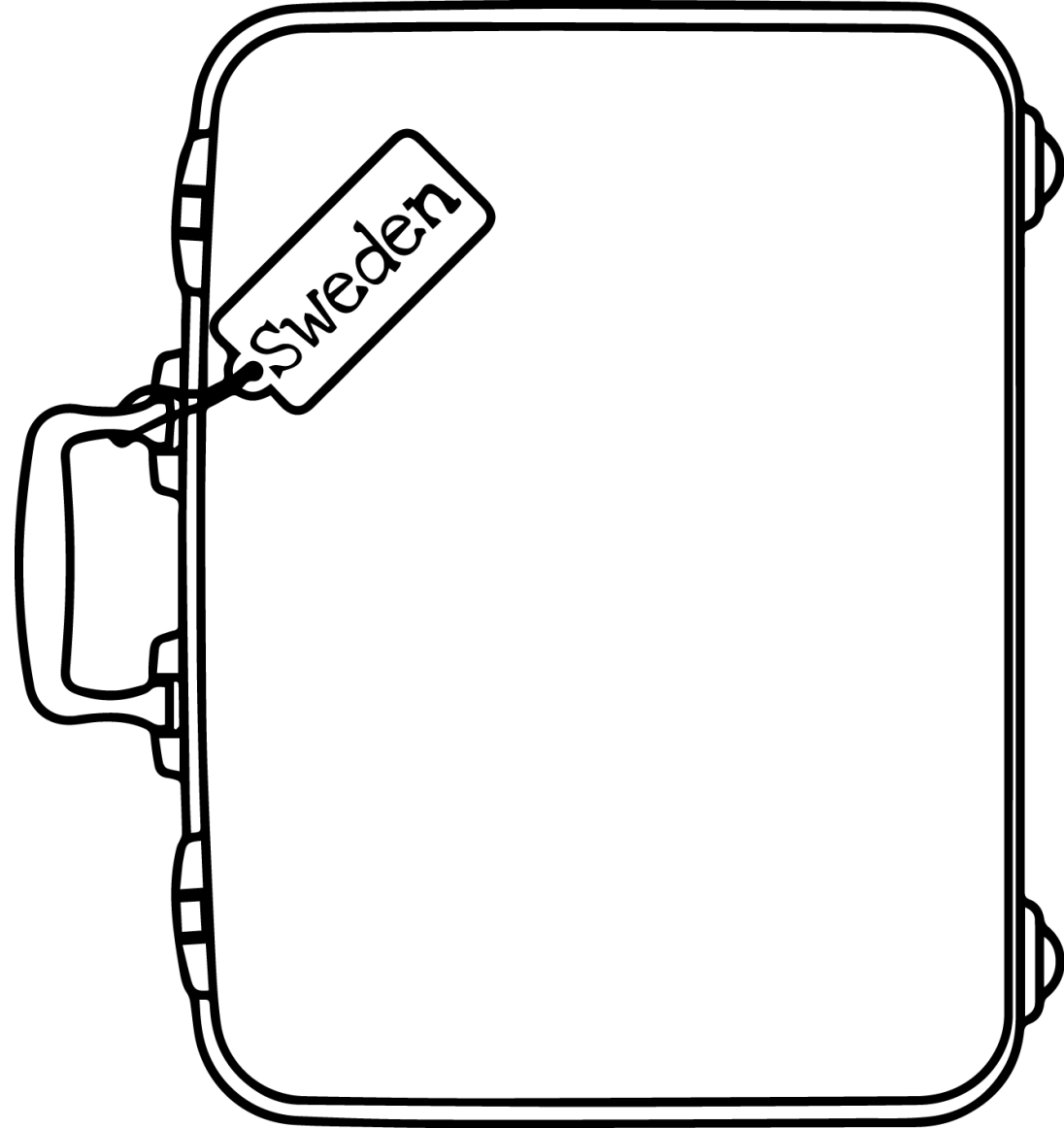

bag

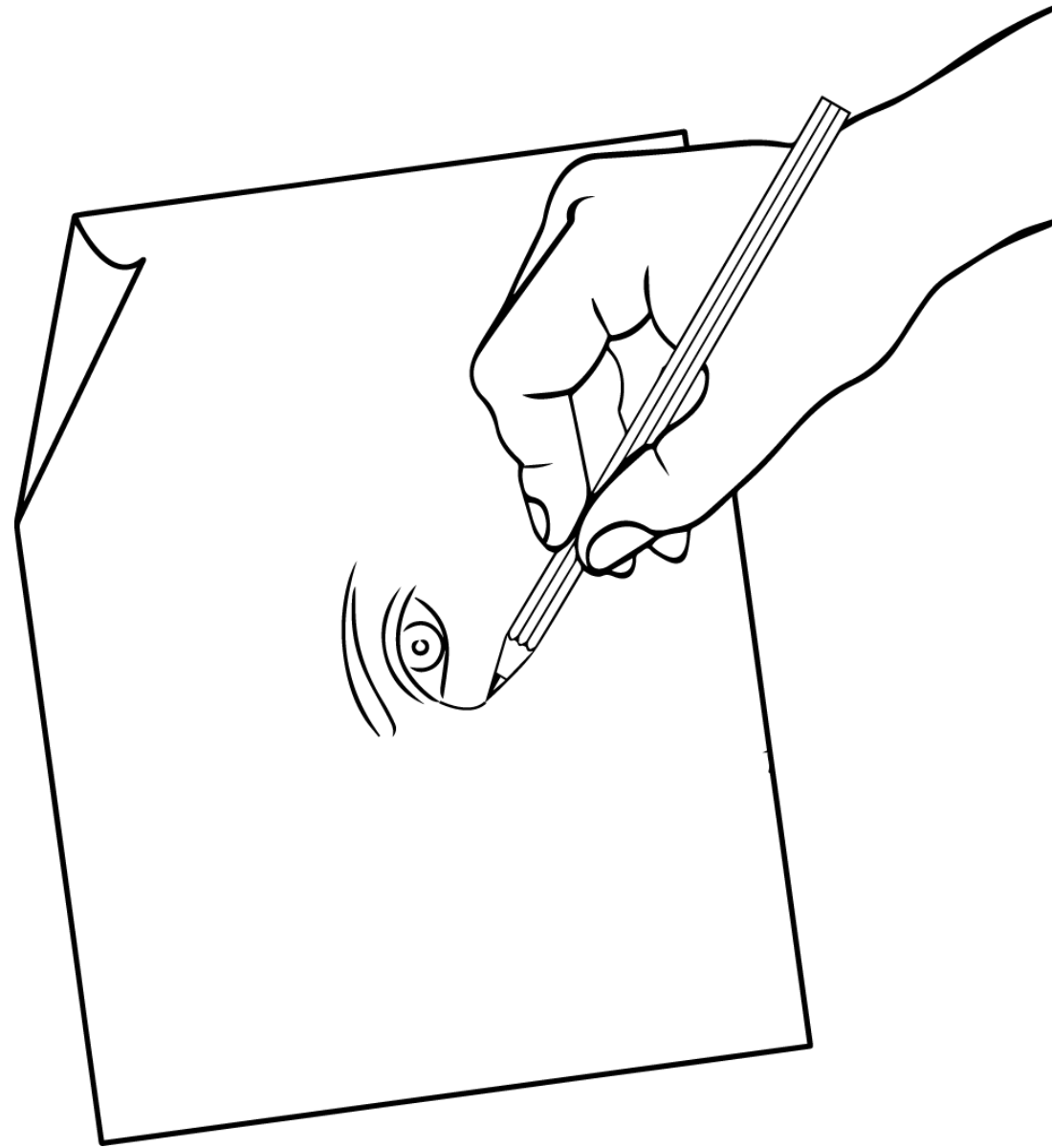

draw

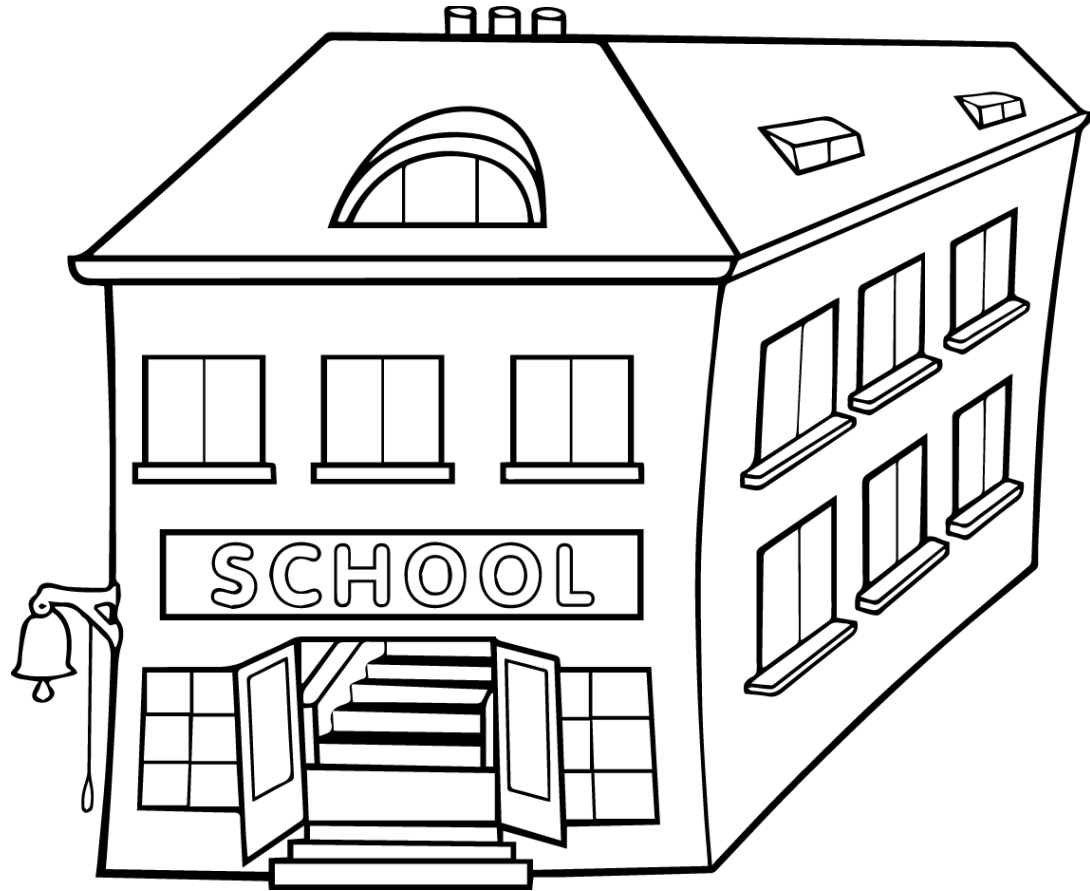

school



story



listen

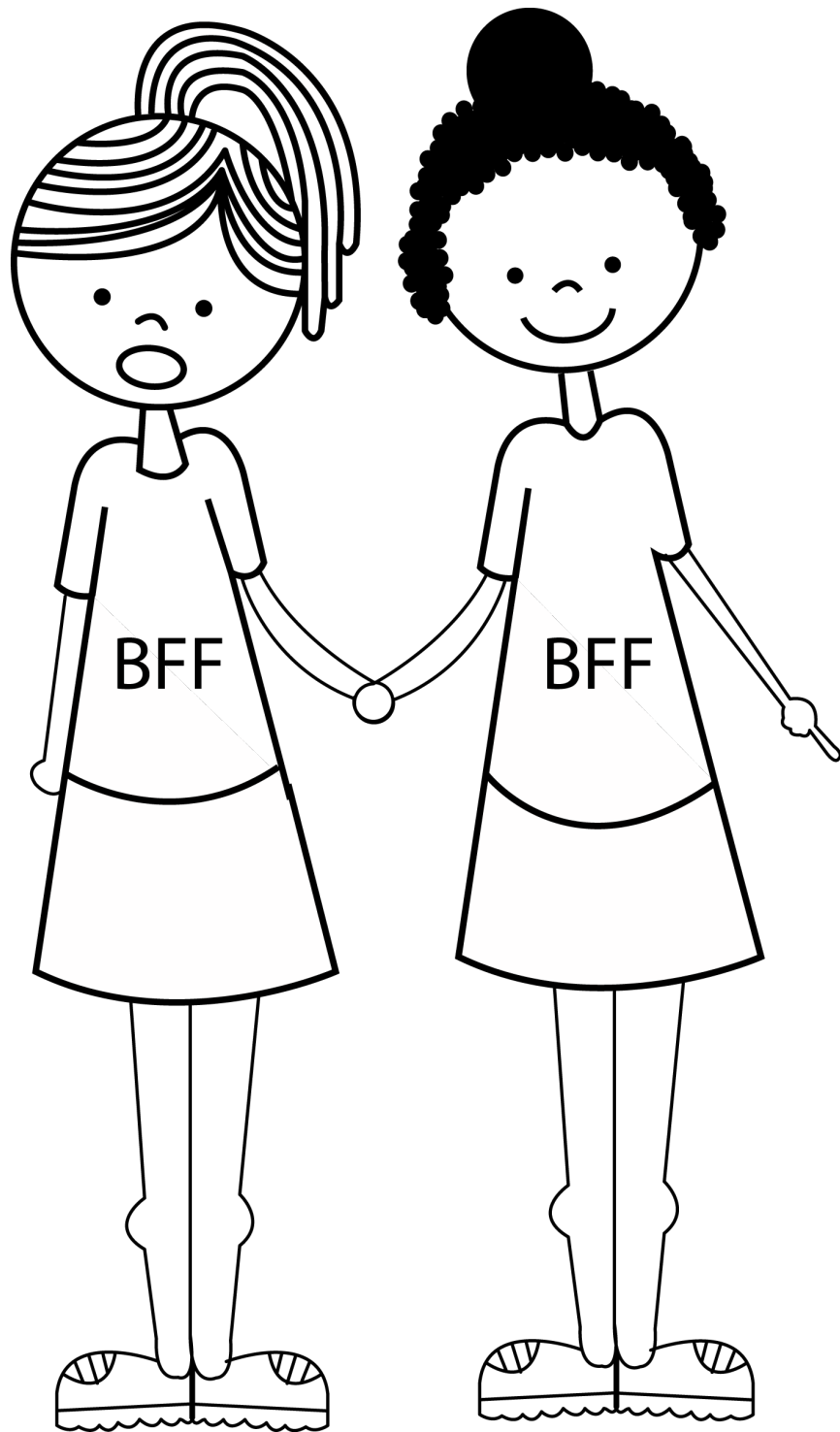

friend

Eeeeeeee!!

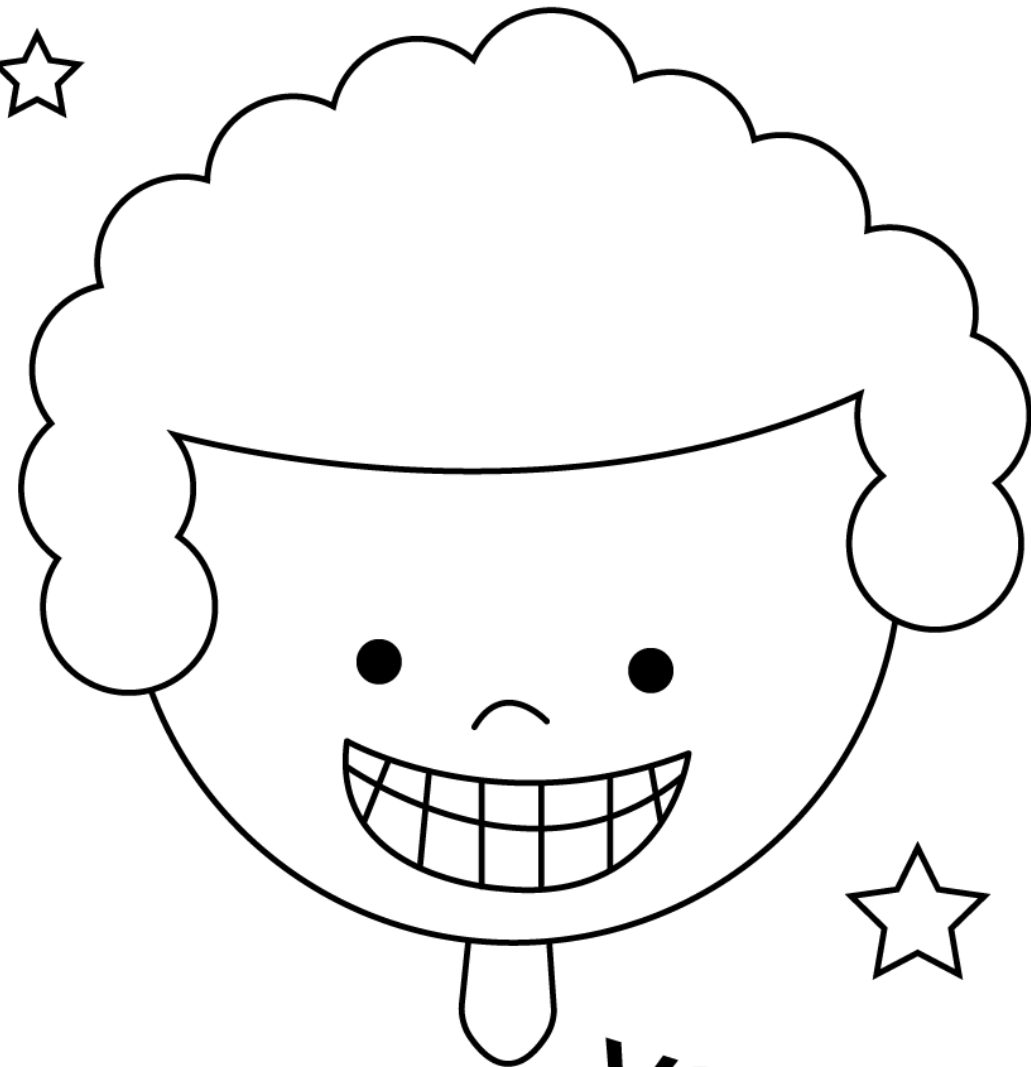

yay!!

excited

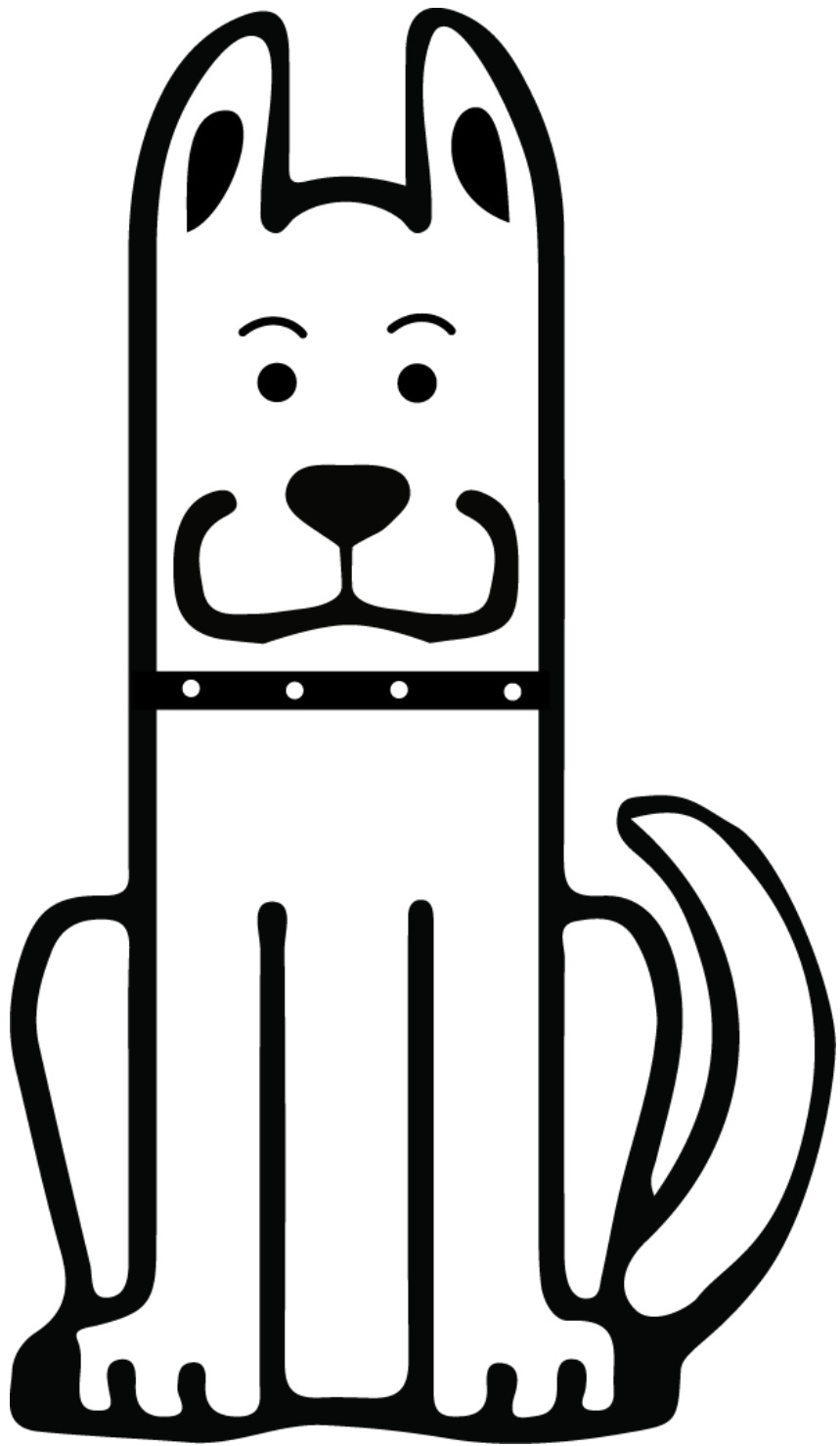

dog

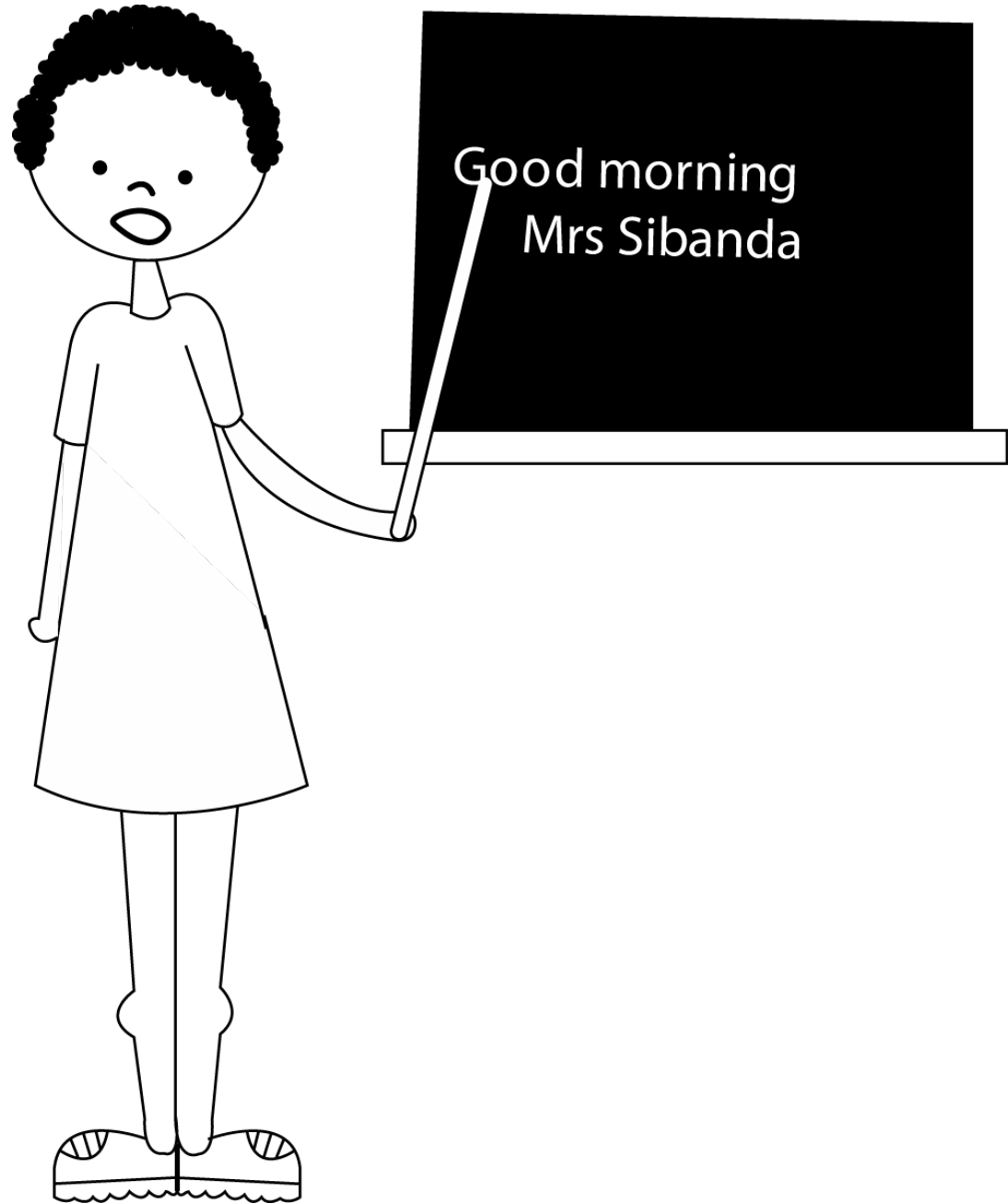

teacher

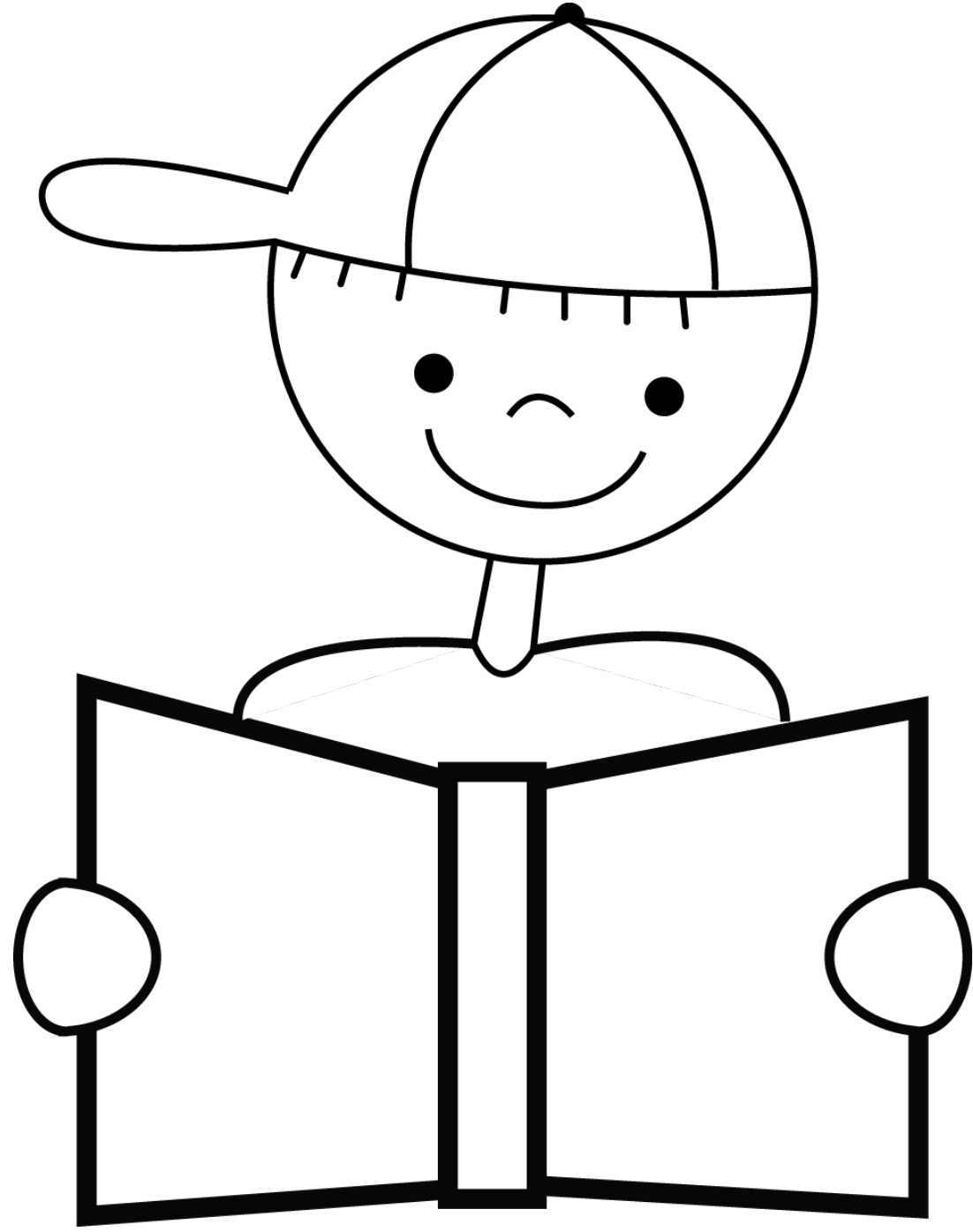

read

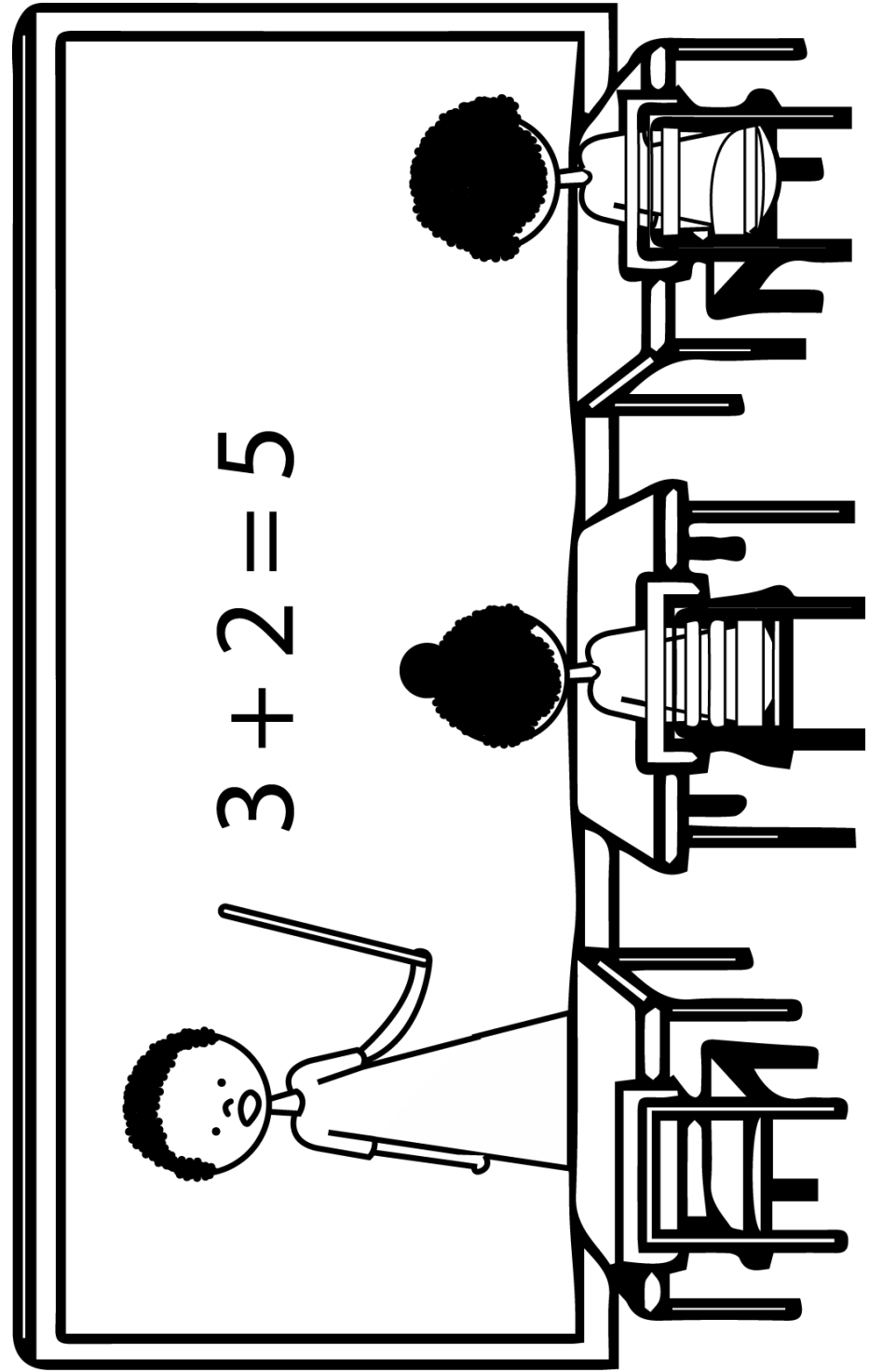

classroom

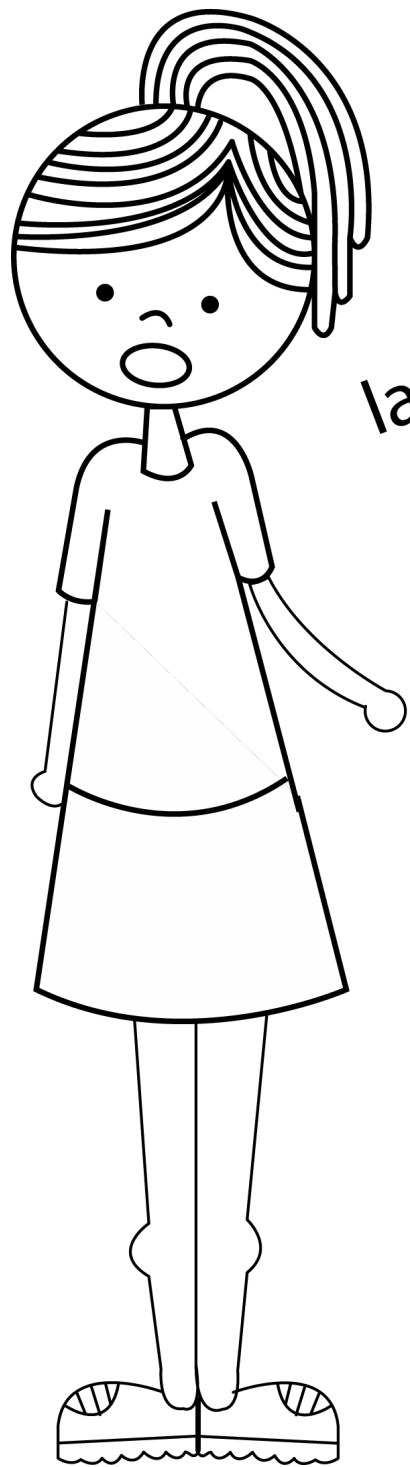

laaa

laaa laaaaaa



sing

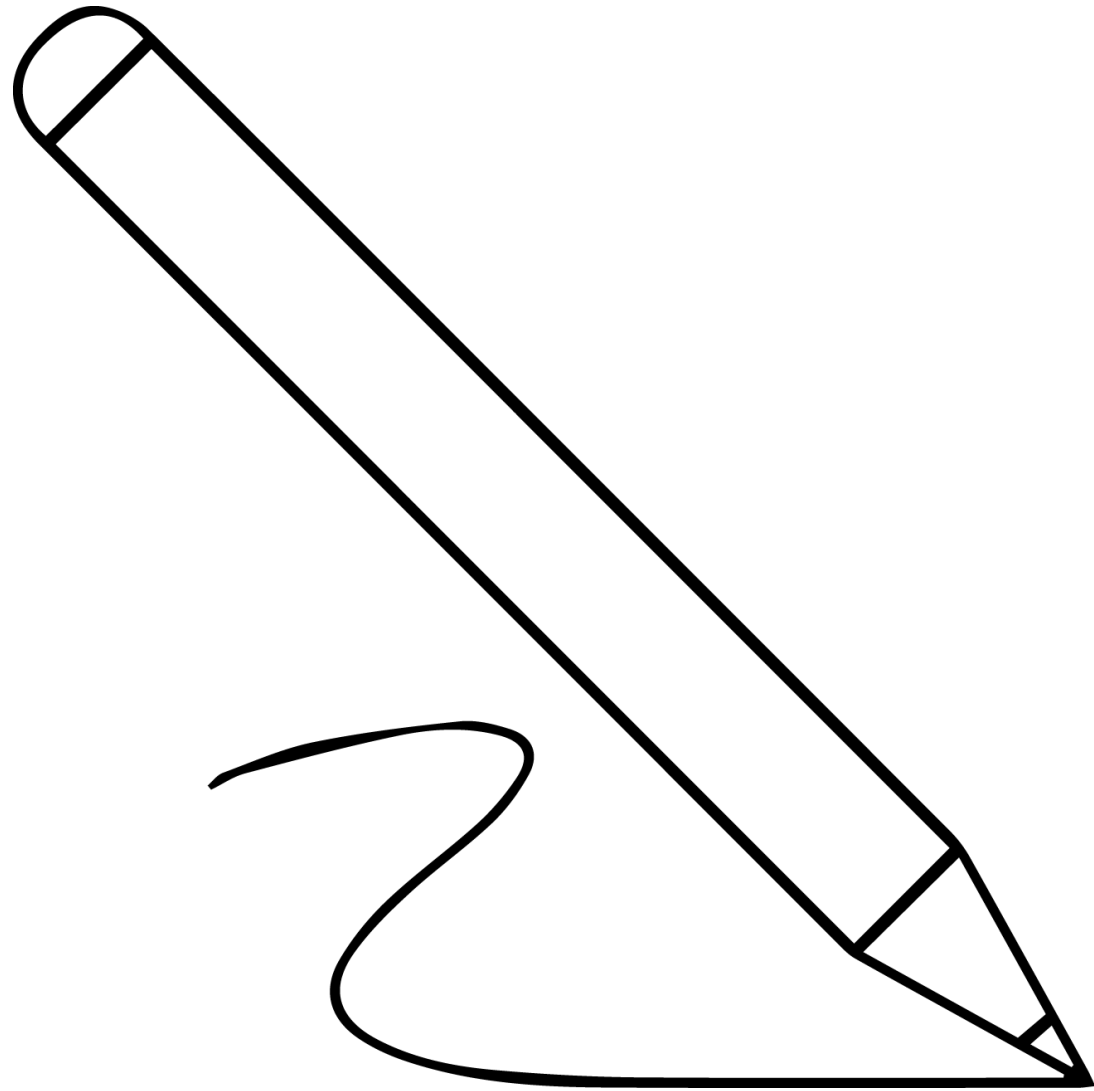

write



first



scared

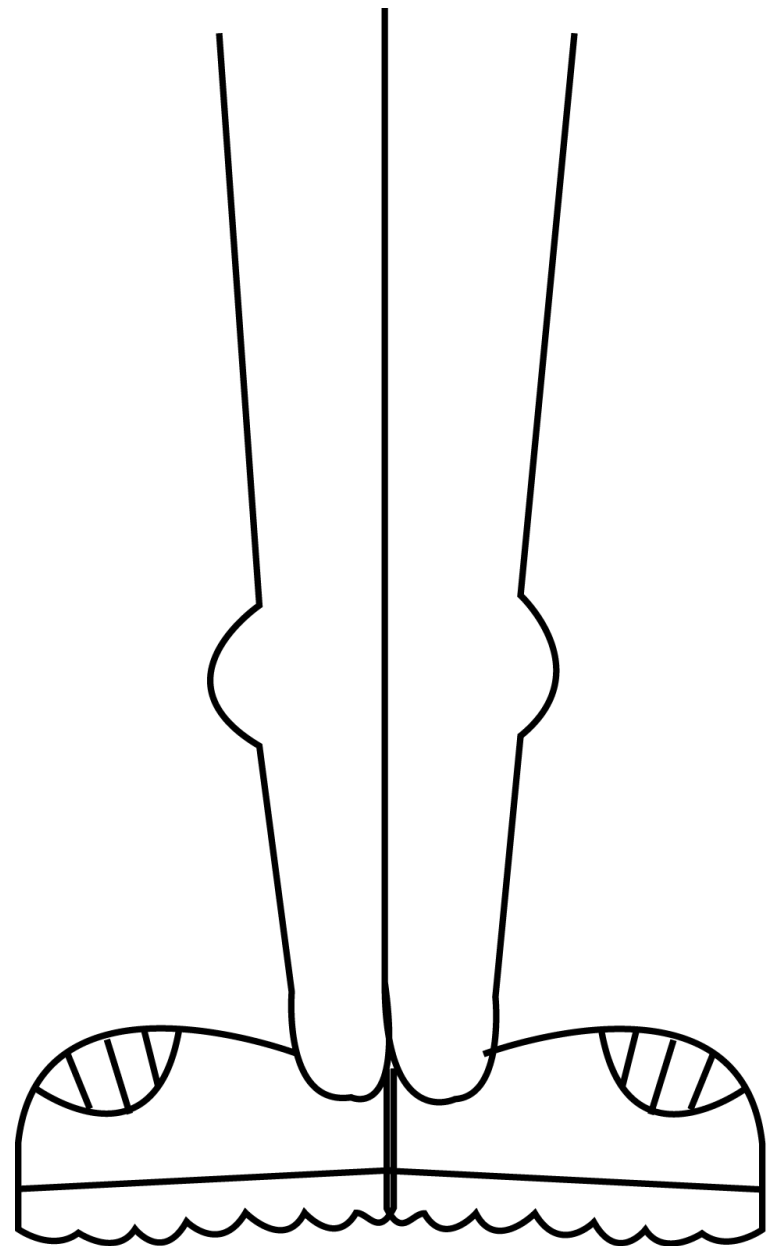

shoes

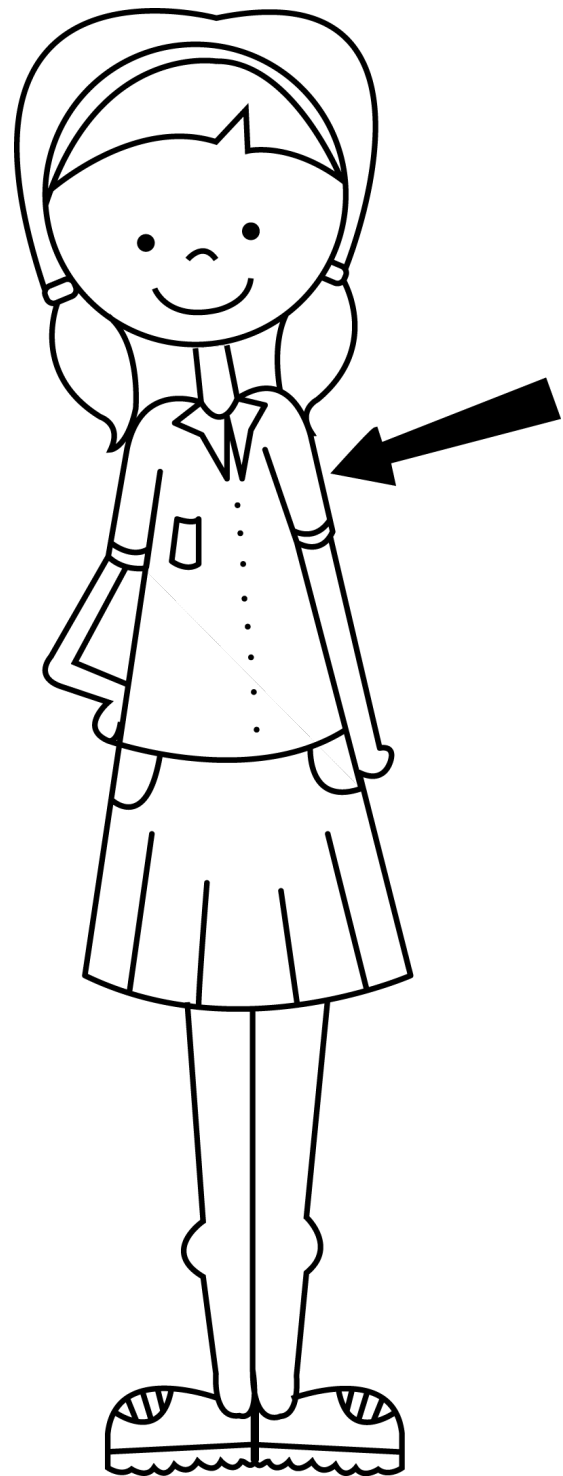
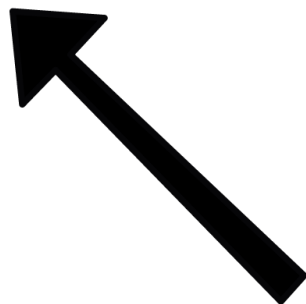

uniform

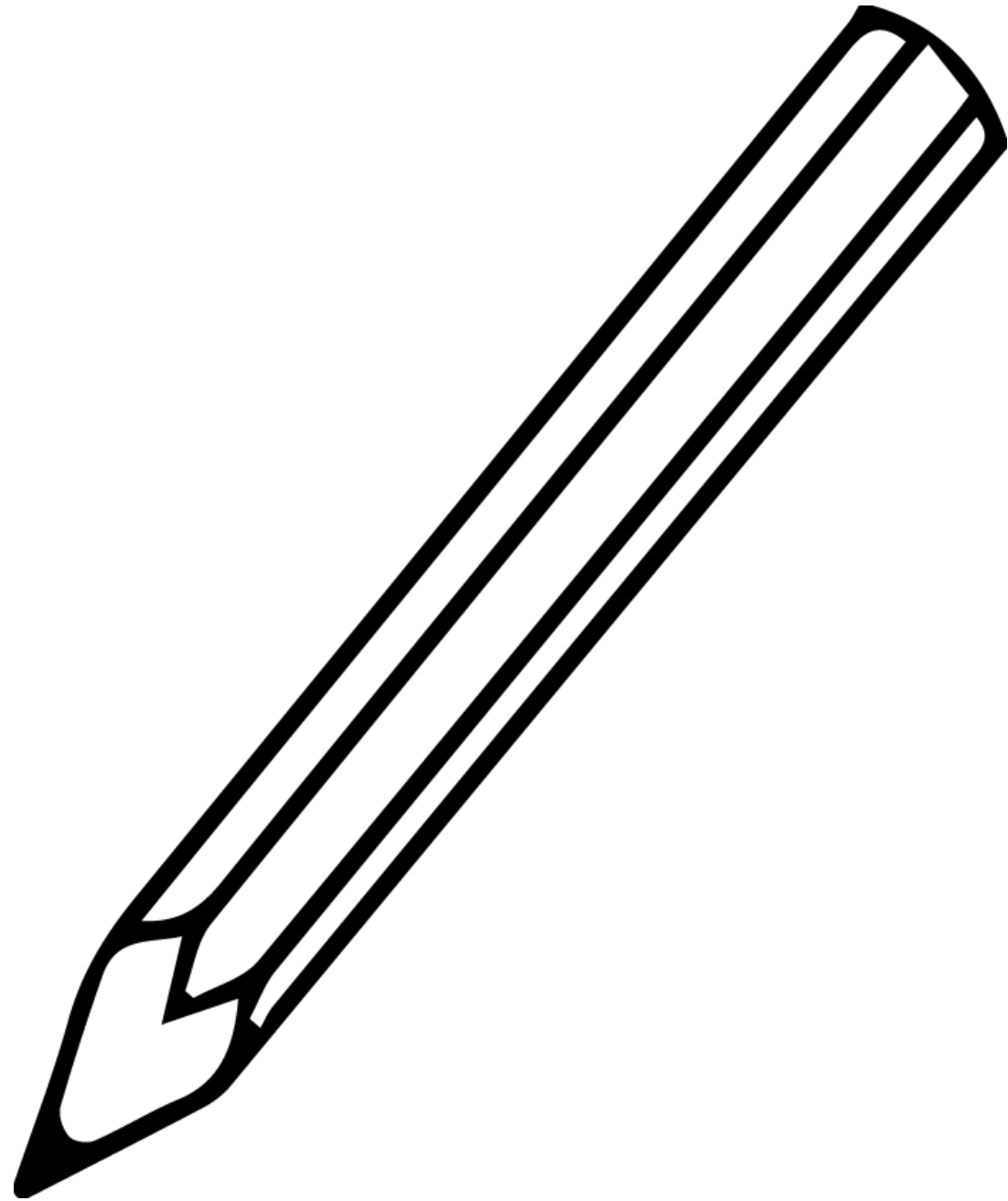

pencil

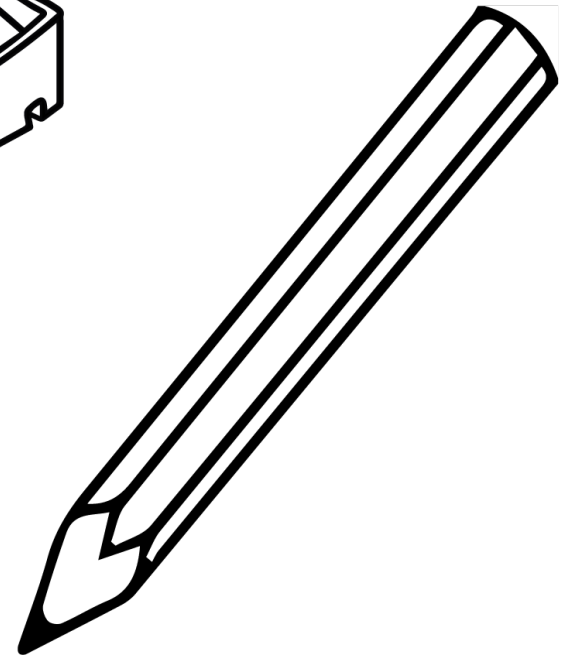
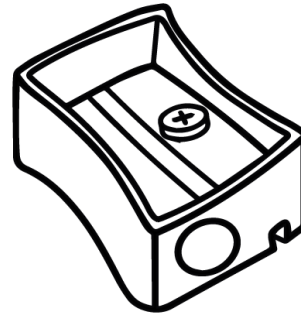
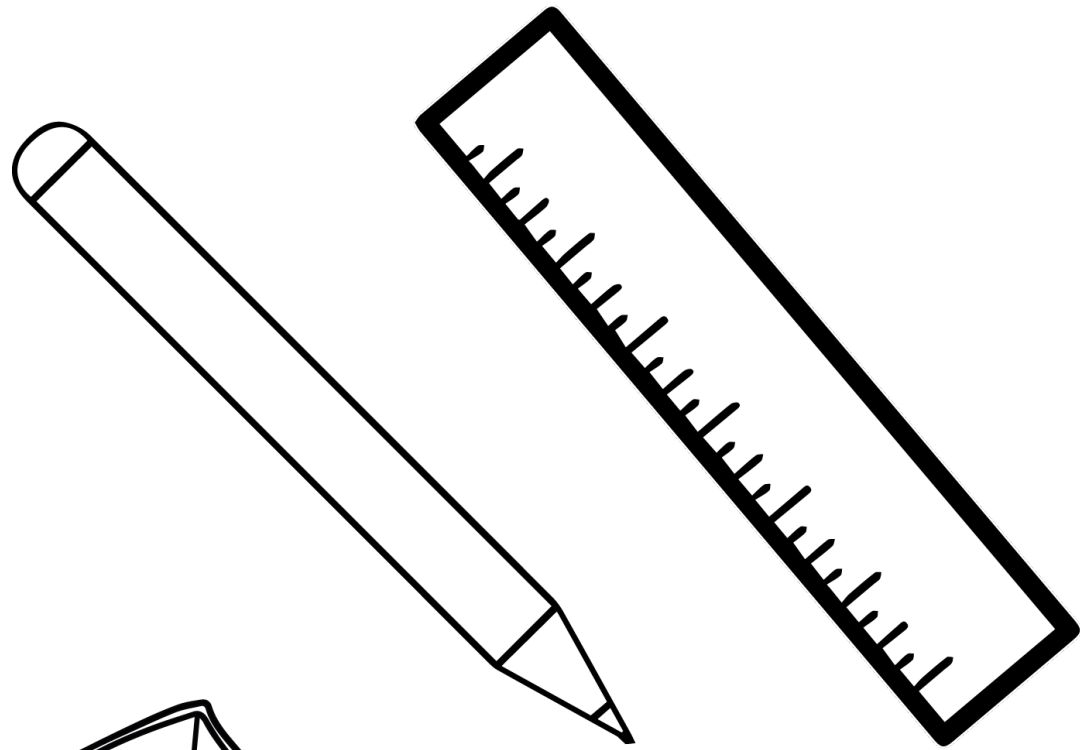

stationery

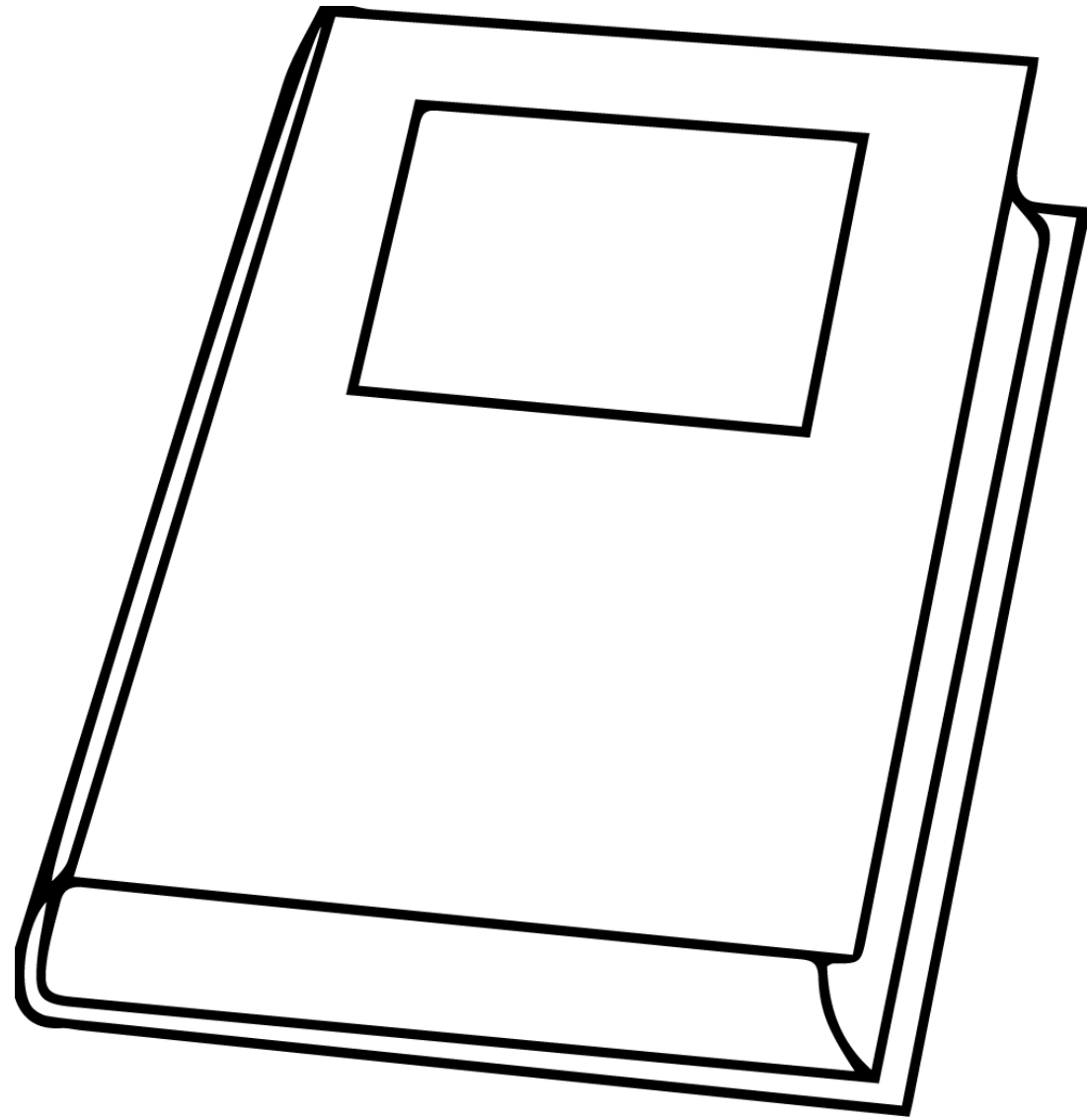

book

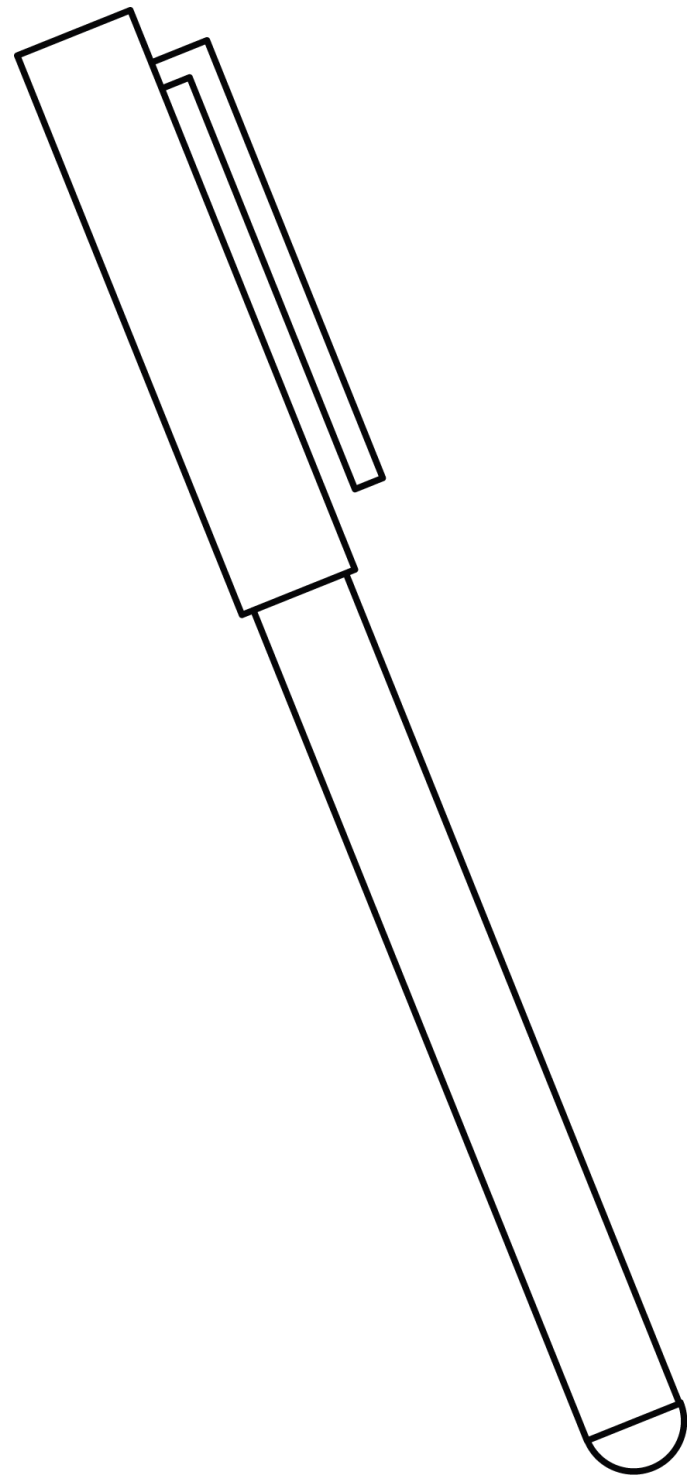

pen

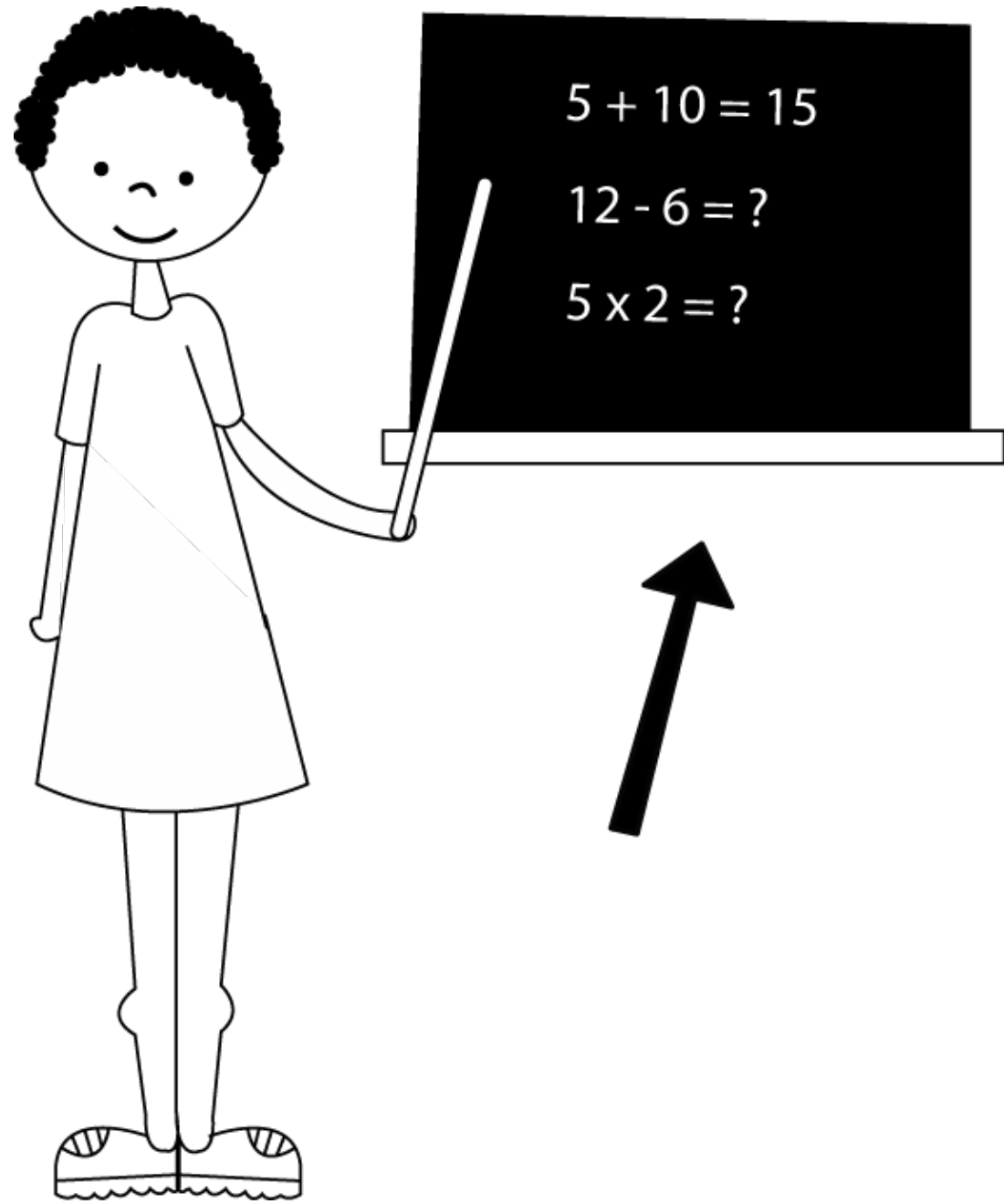

teach

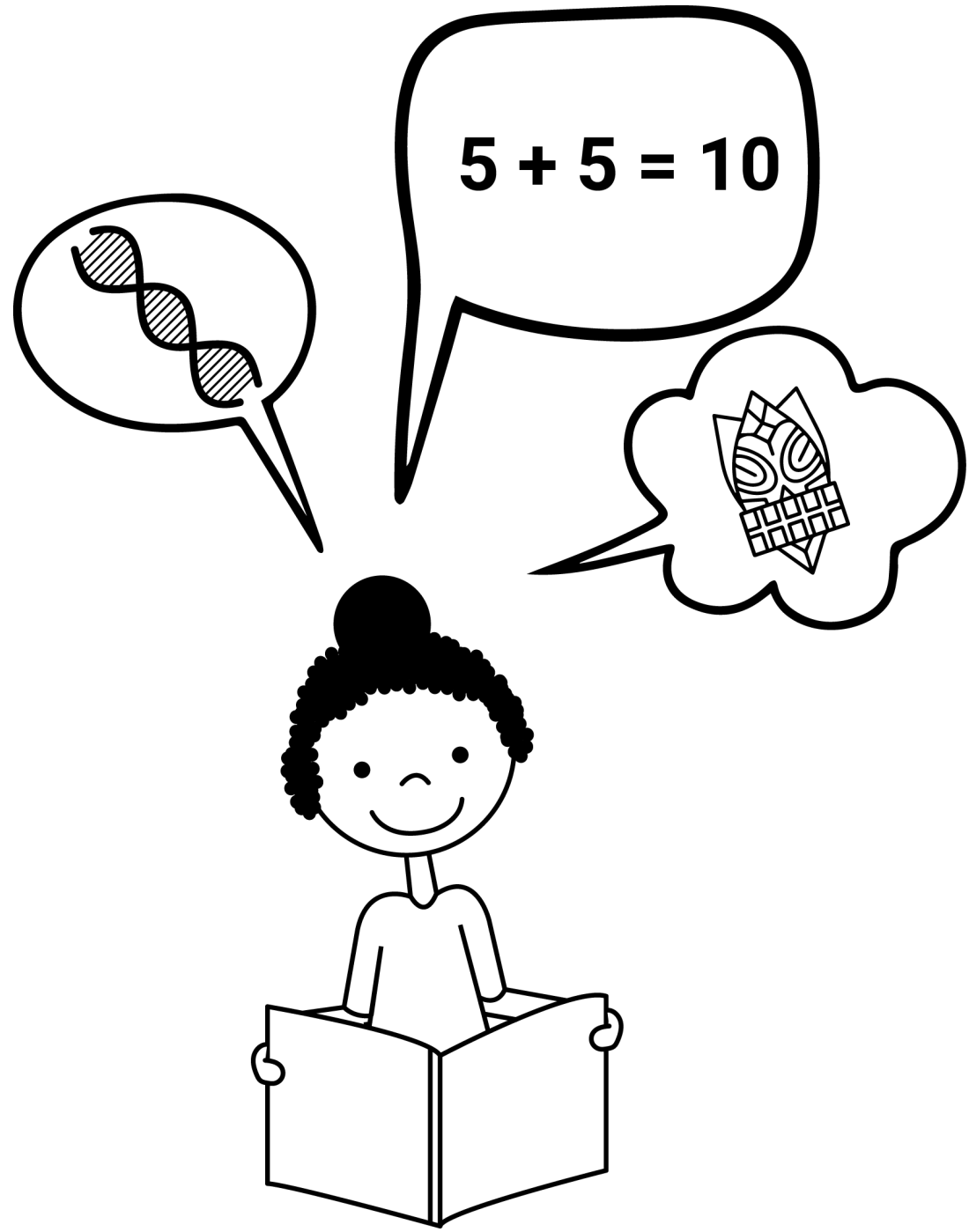

learn

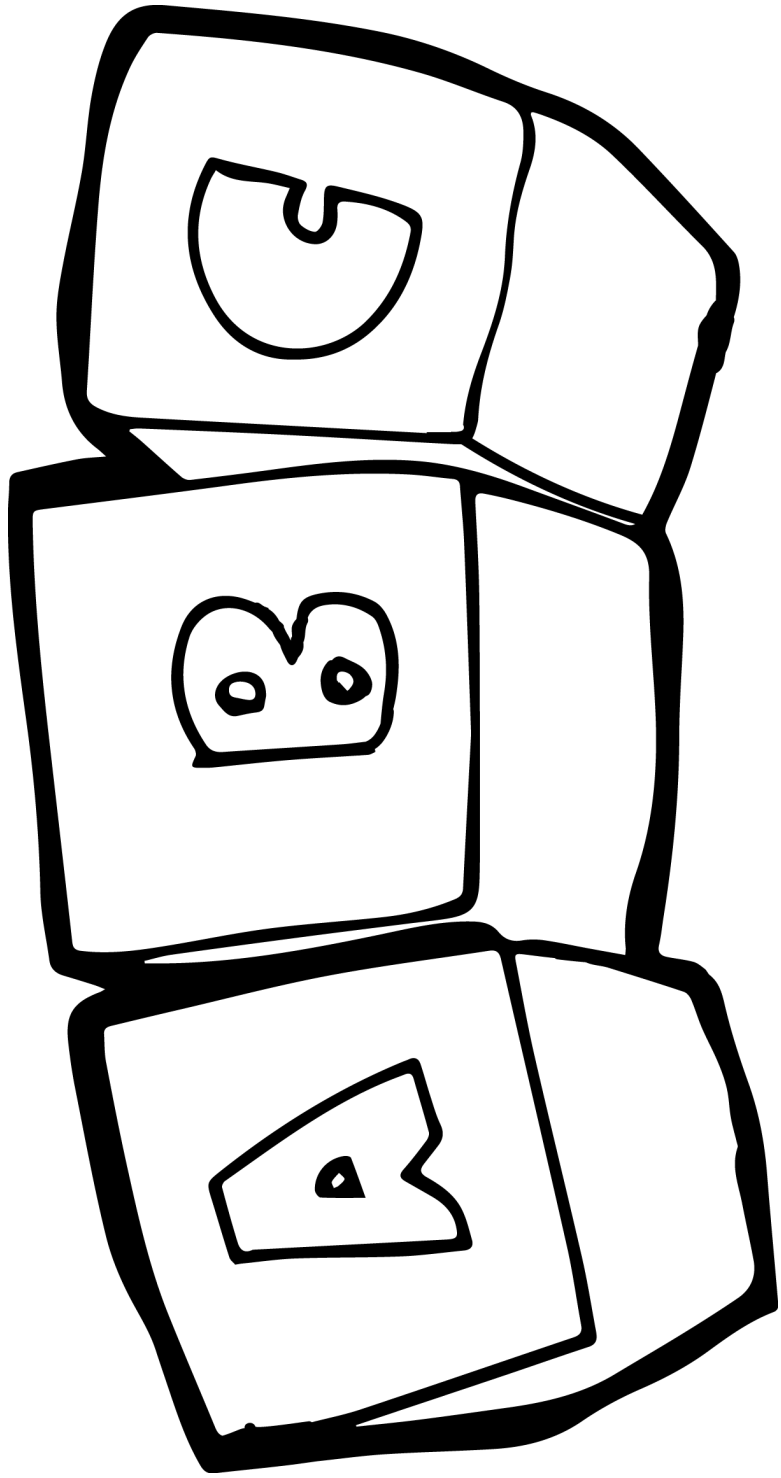

letters

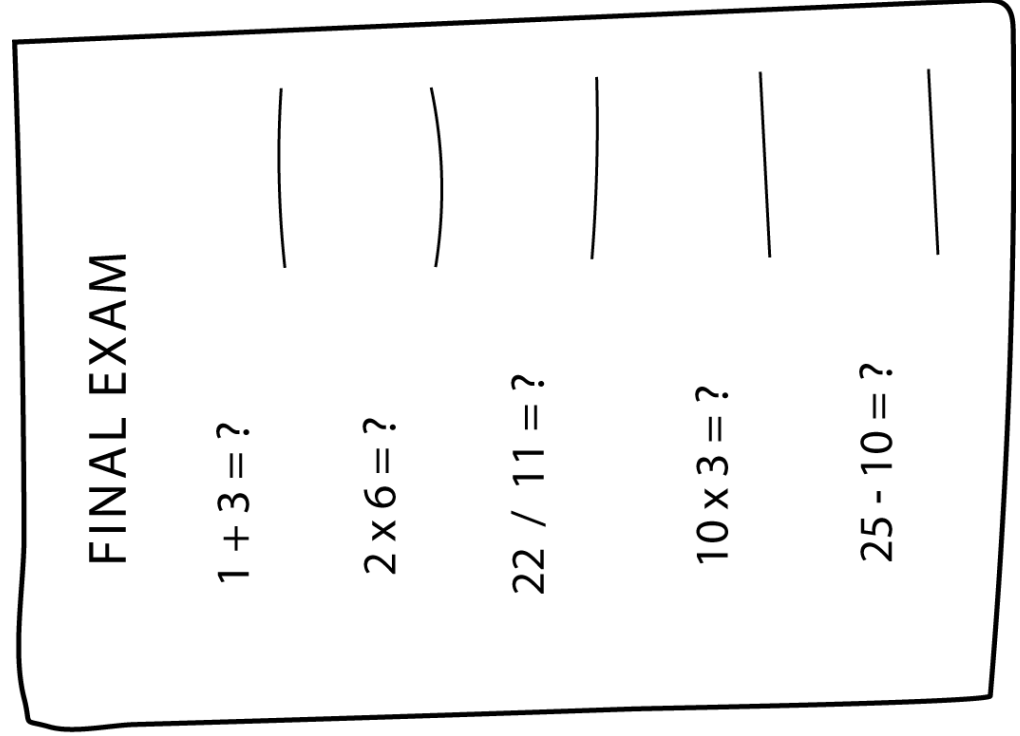

maths

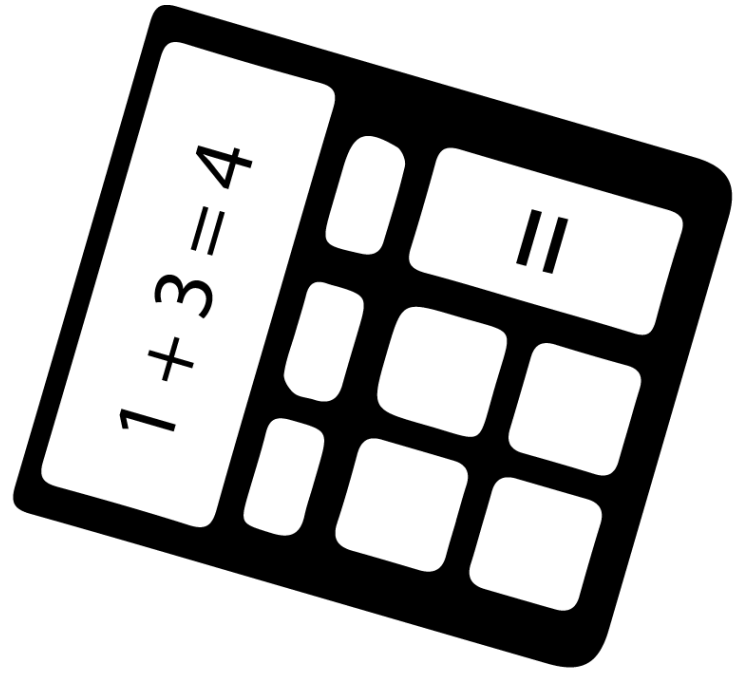

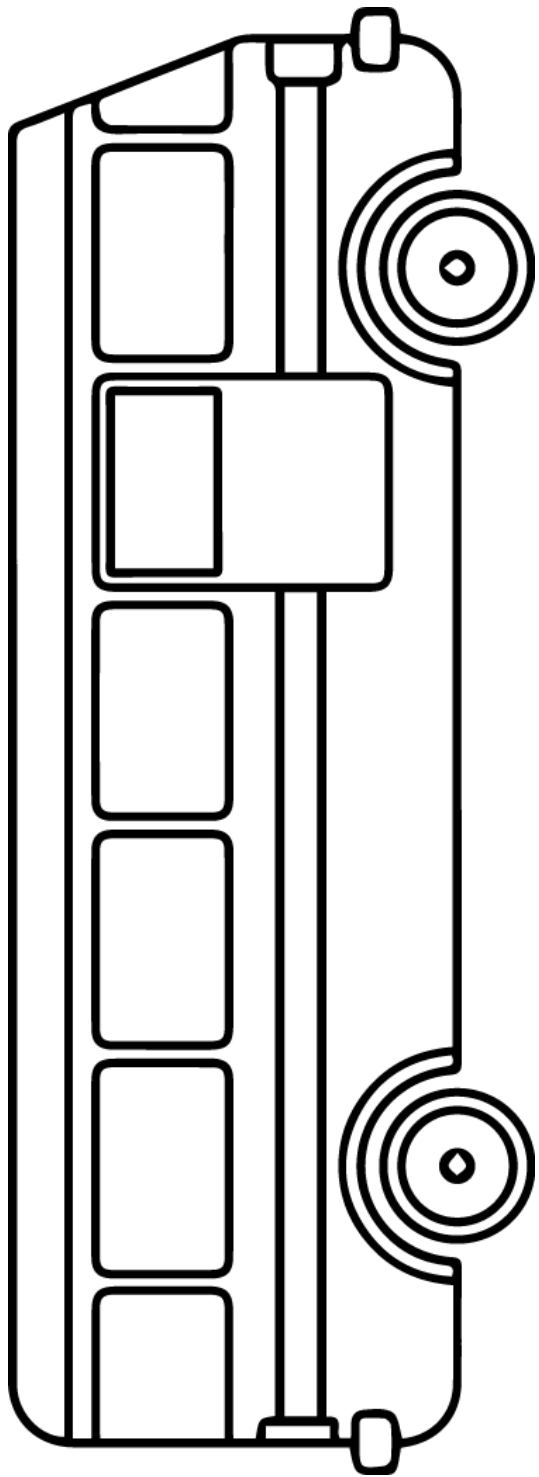

bus



taxi

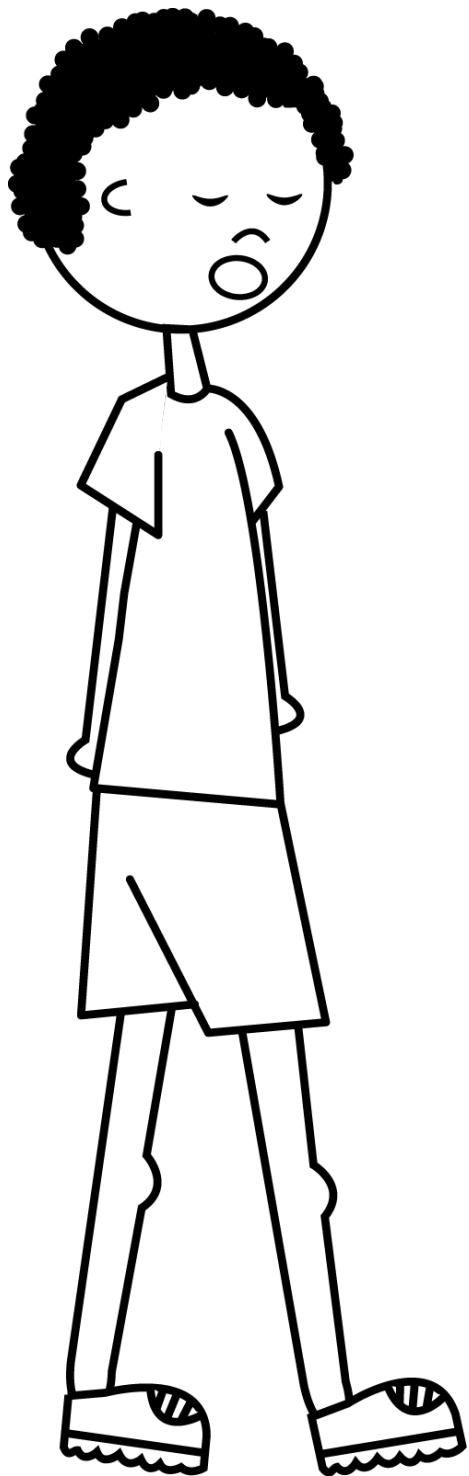

walk

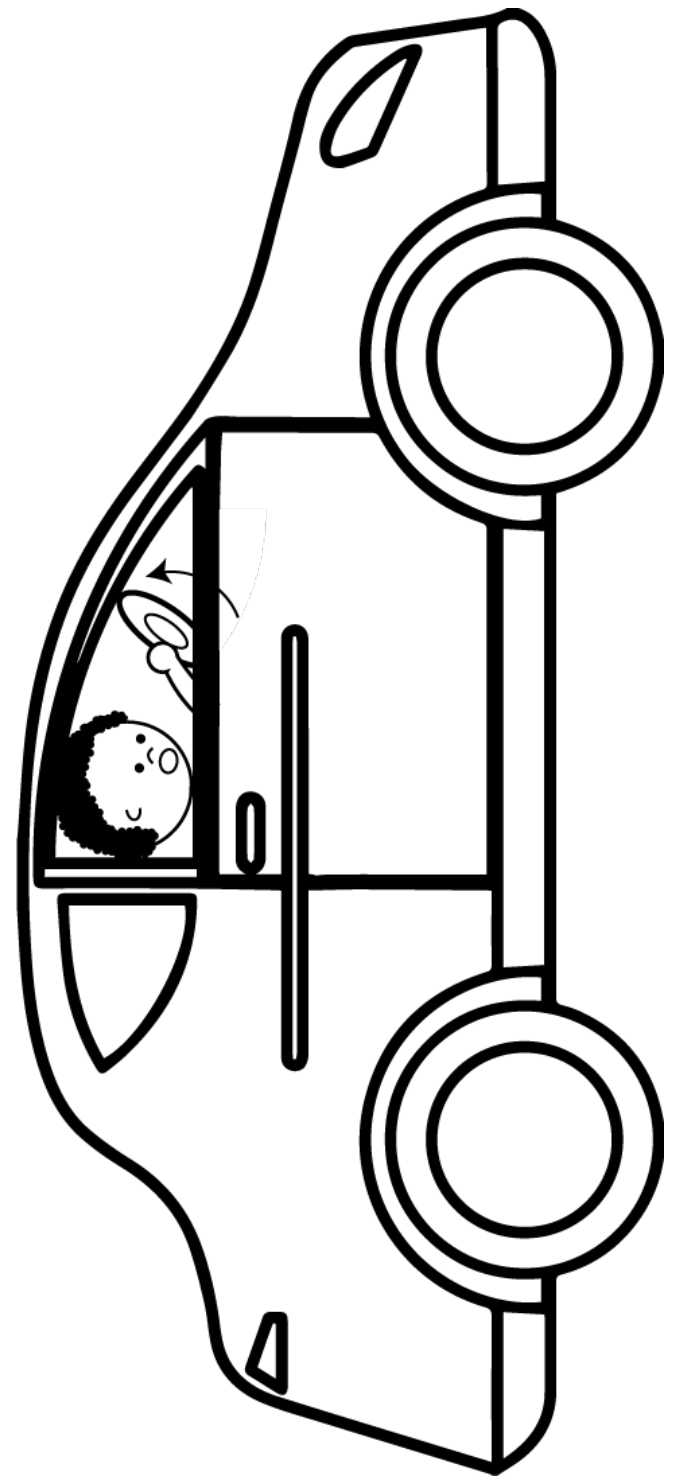

drive

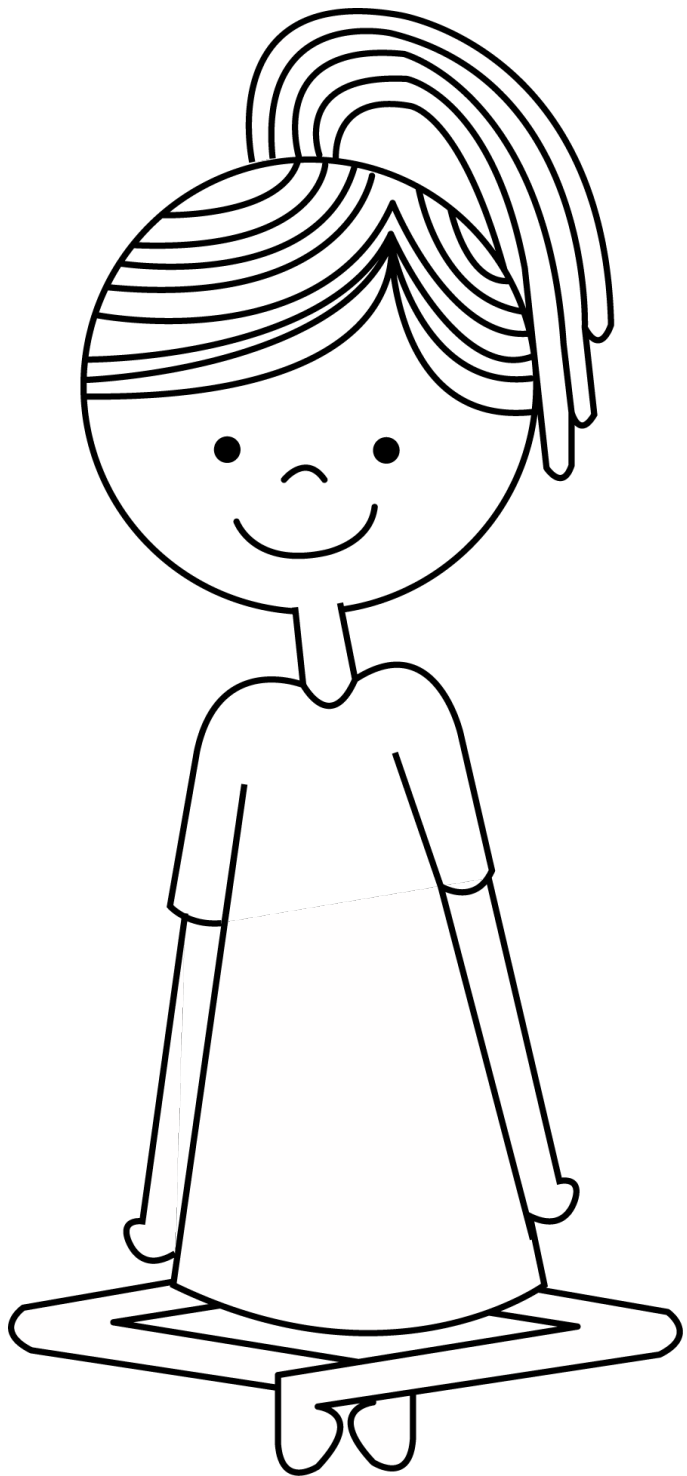

sit

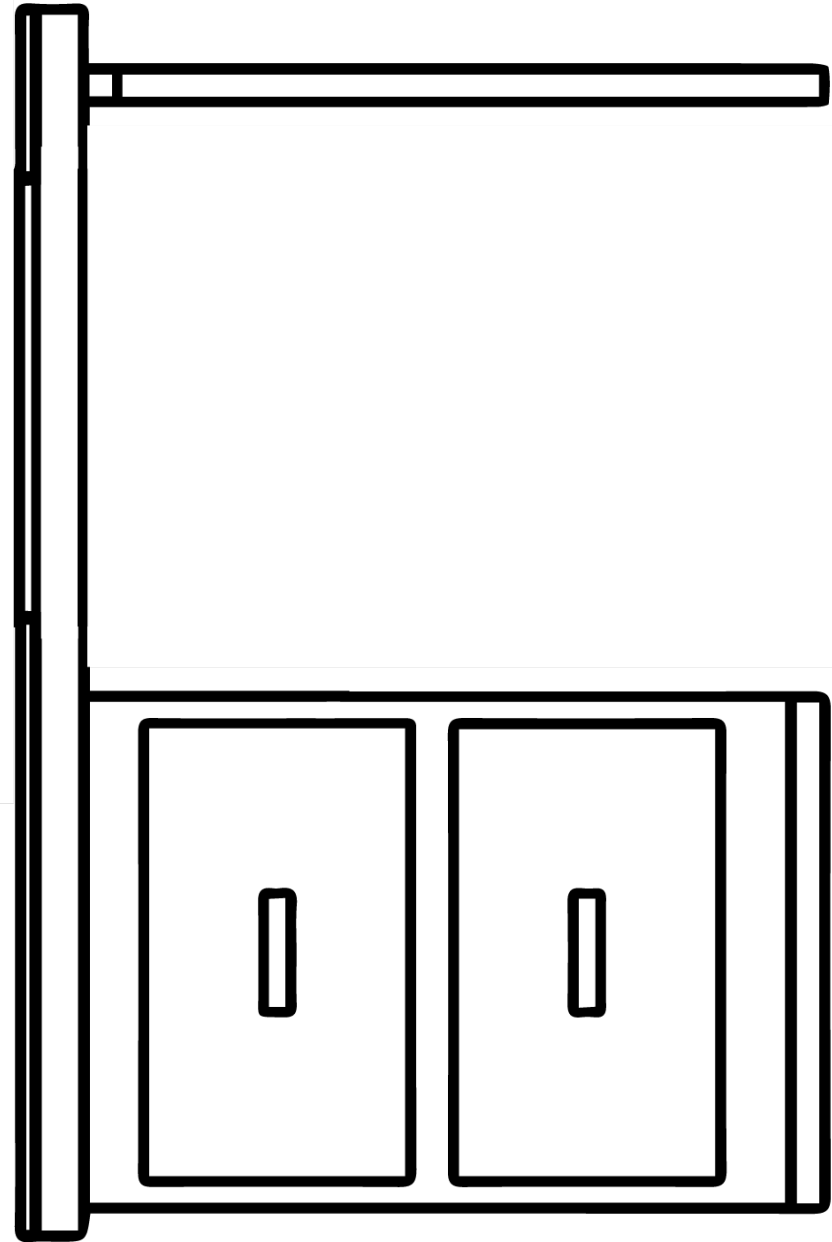

desk

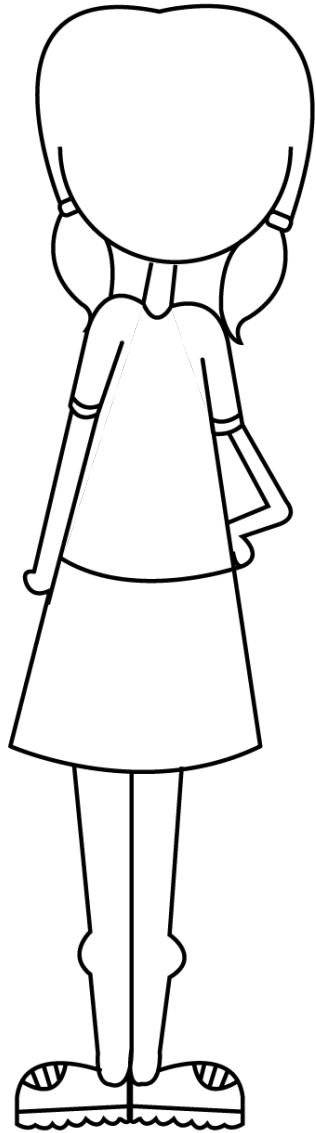
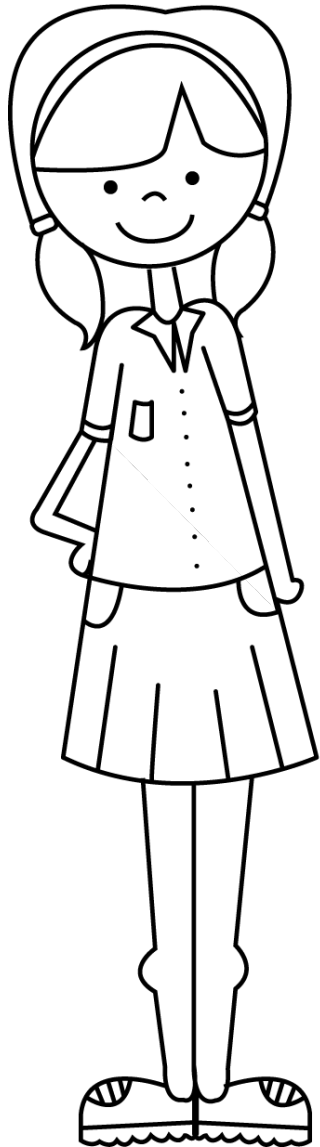
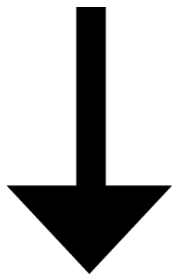

back

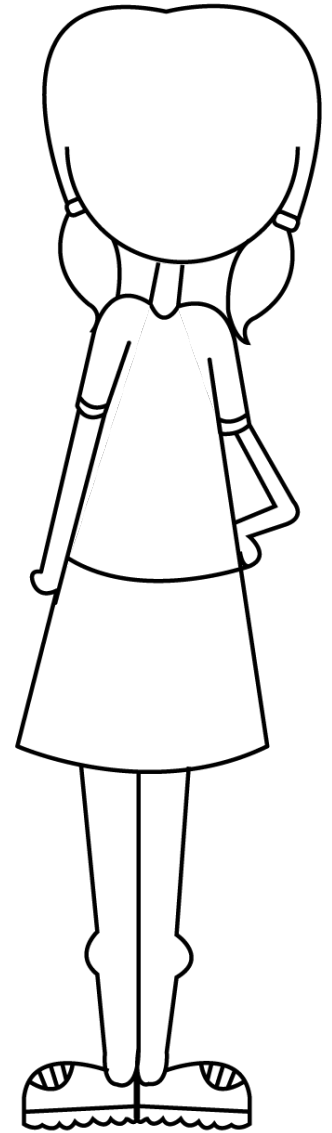
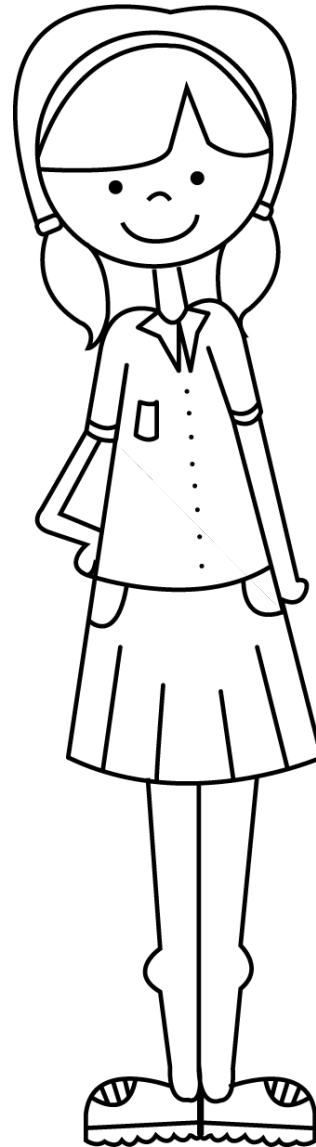
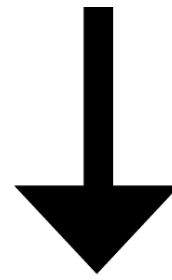

front

3m

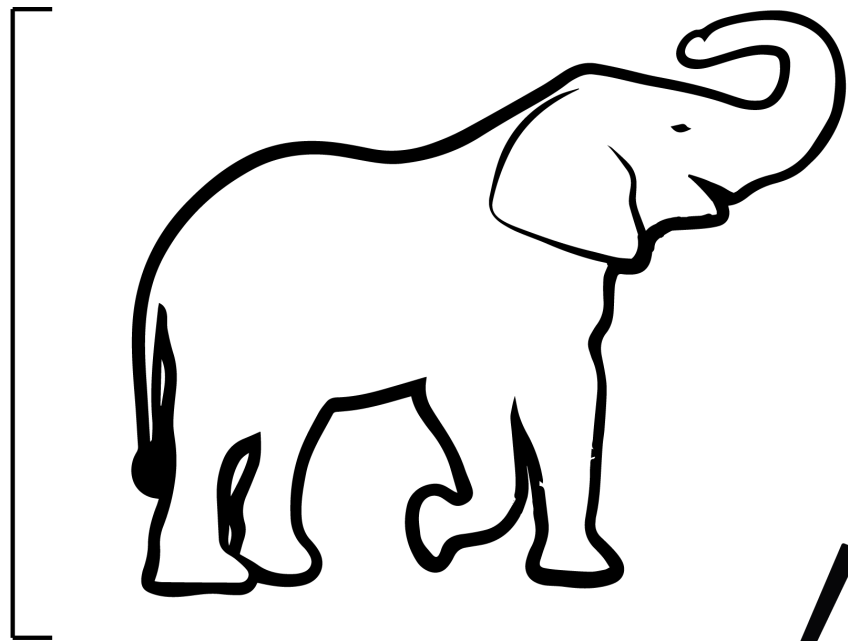

5cm



small

3m

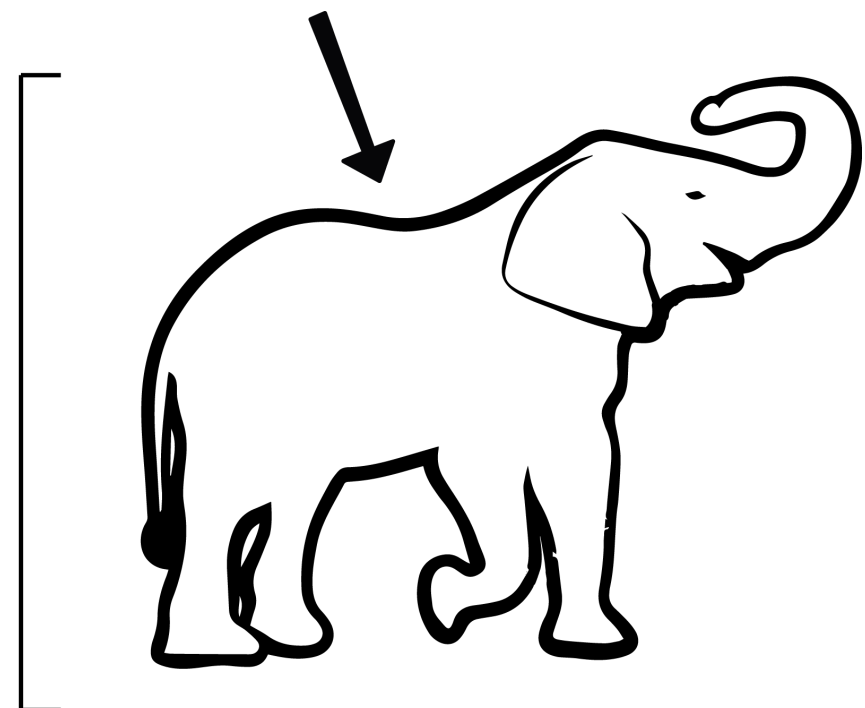

5cm



big

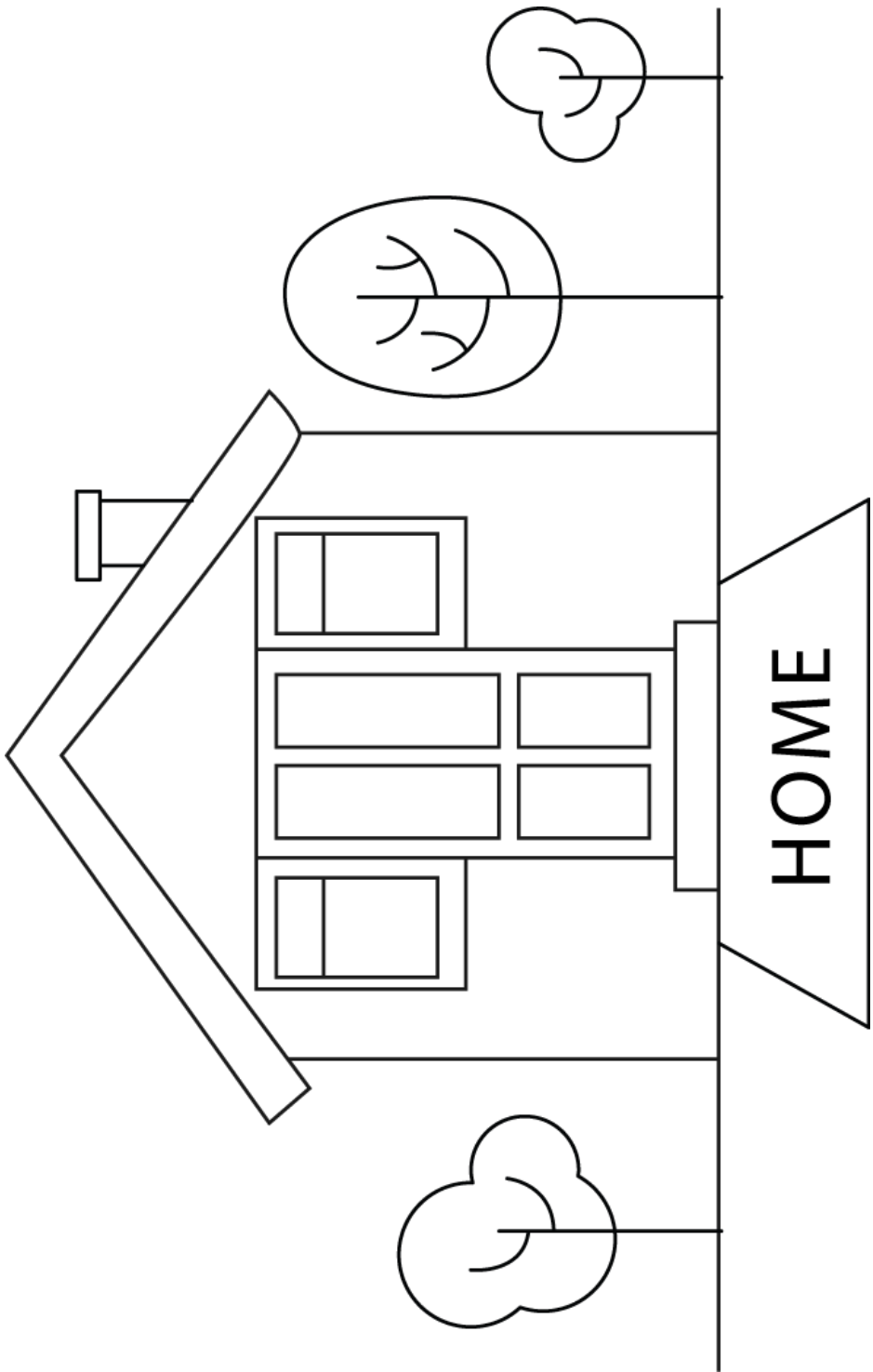

home

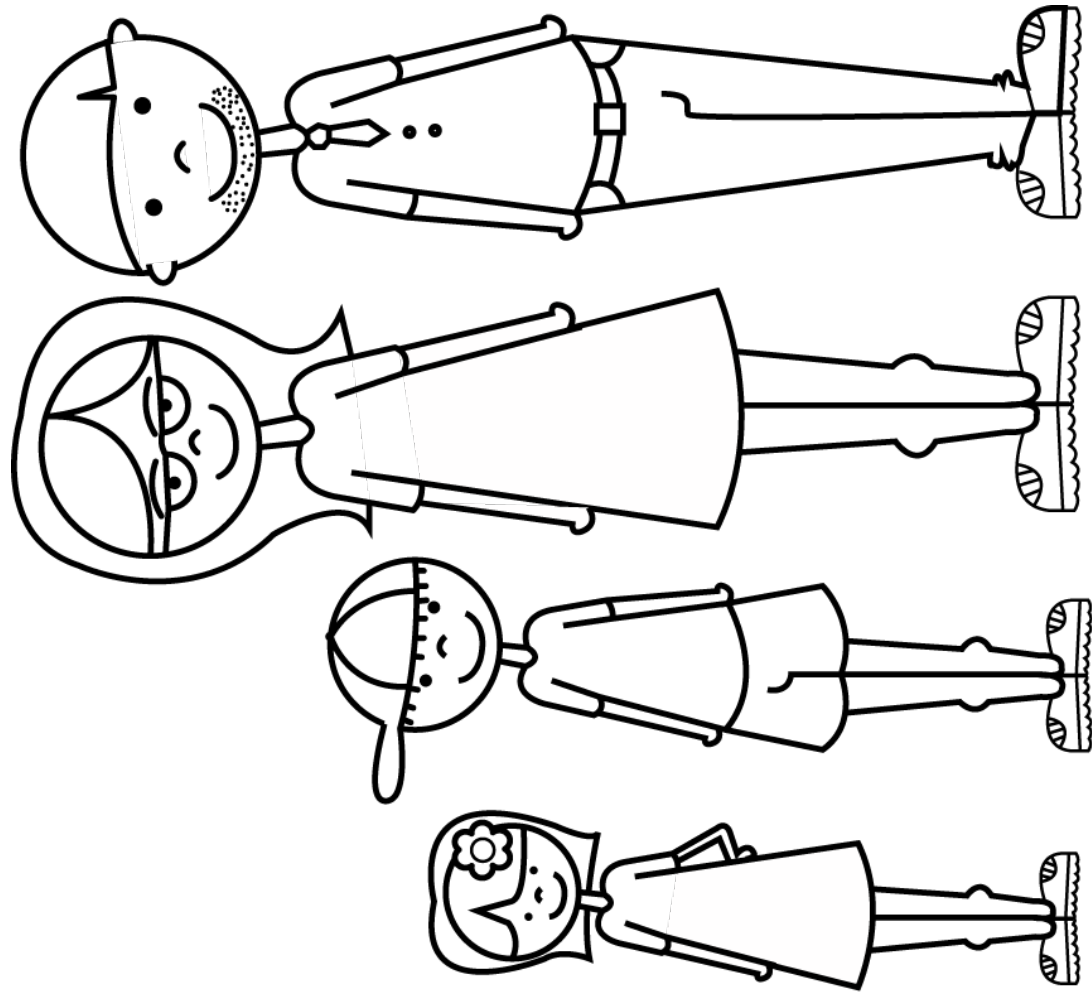

family

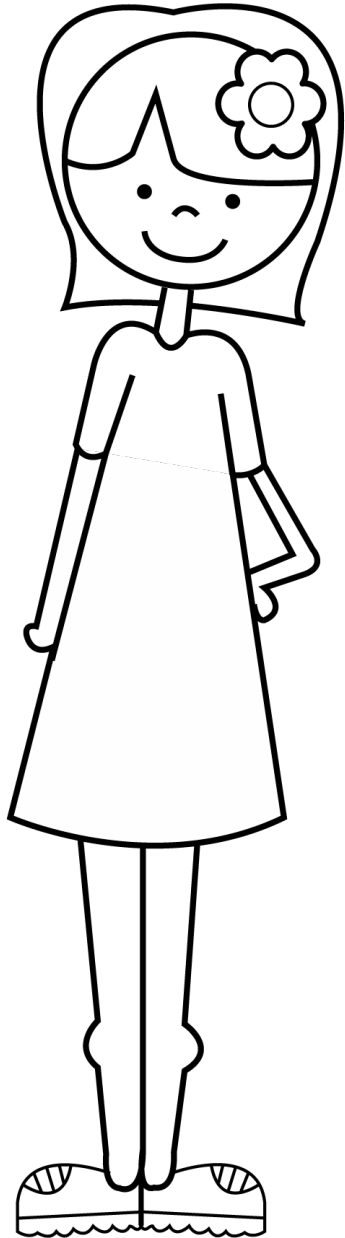

sister

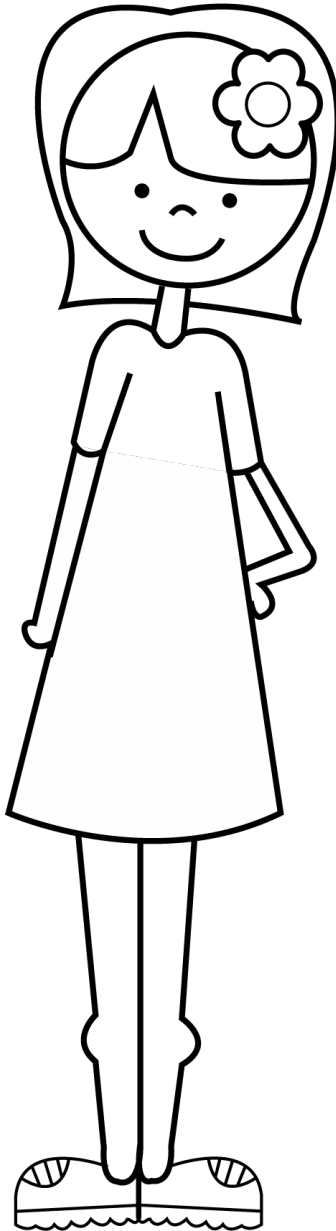
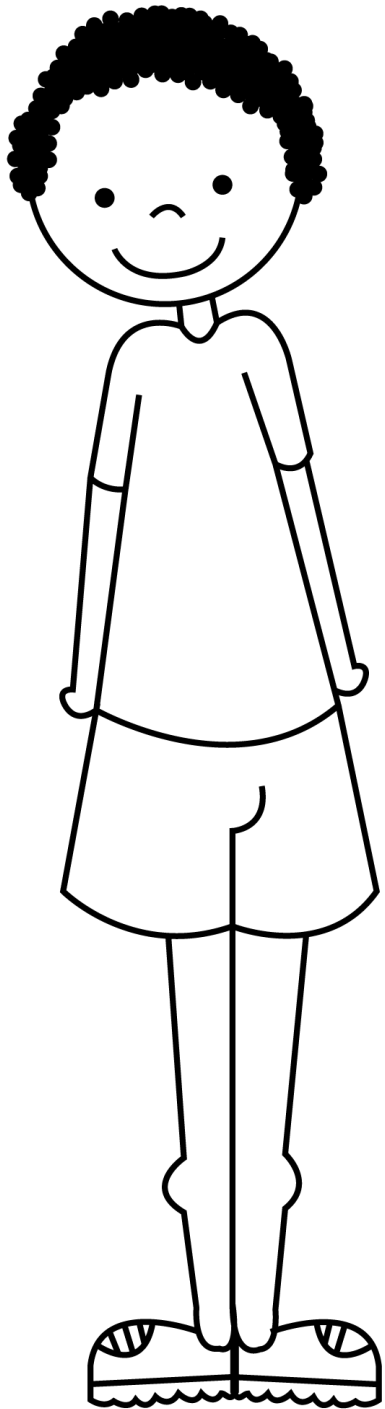

brother

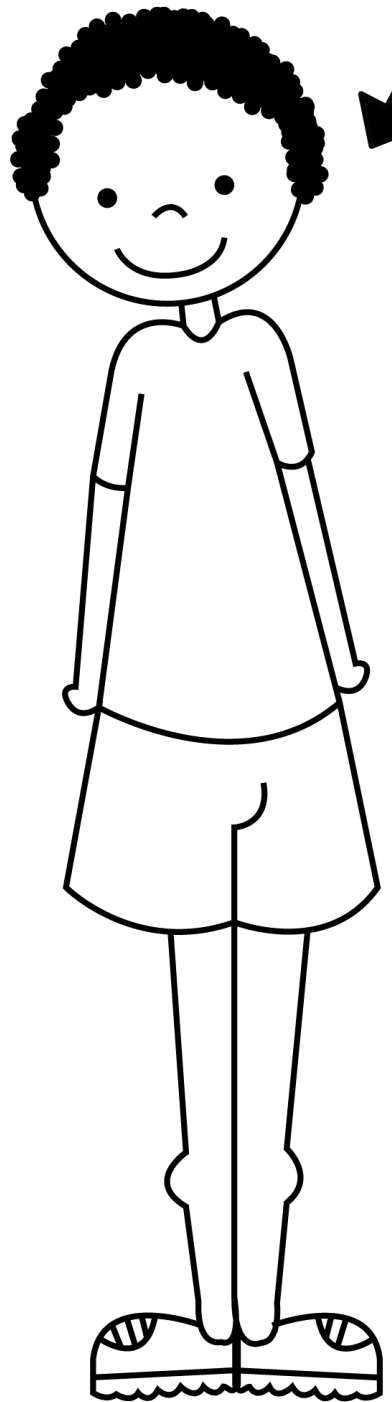

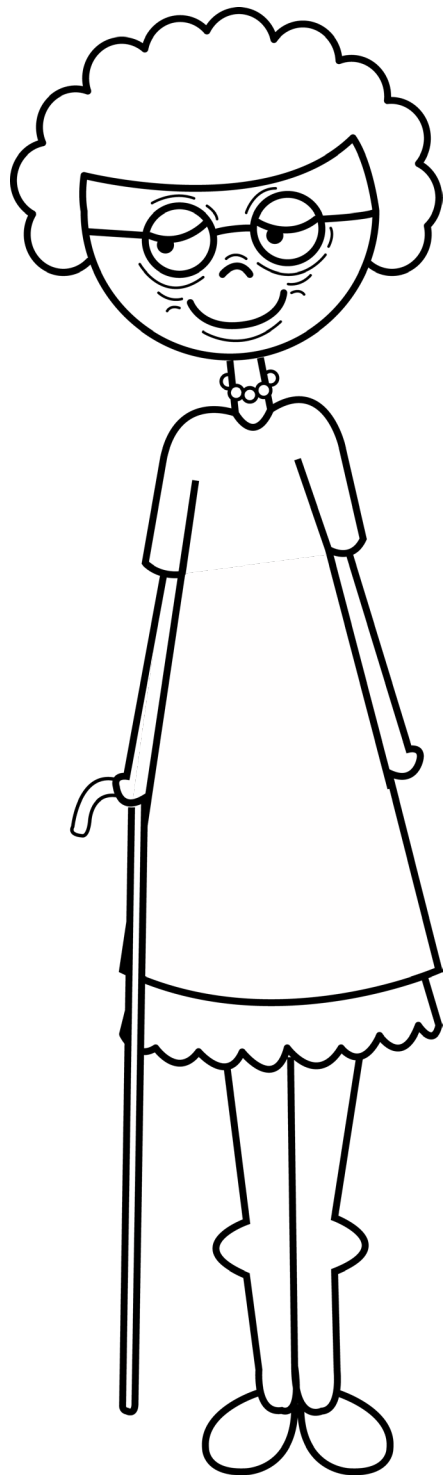

grandmother

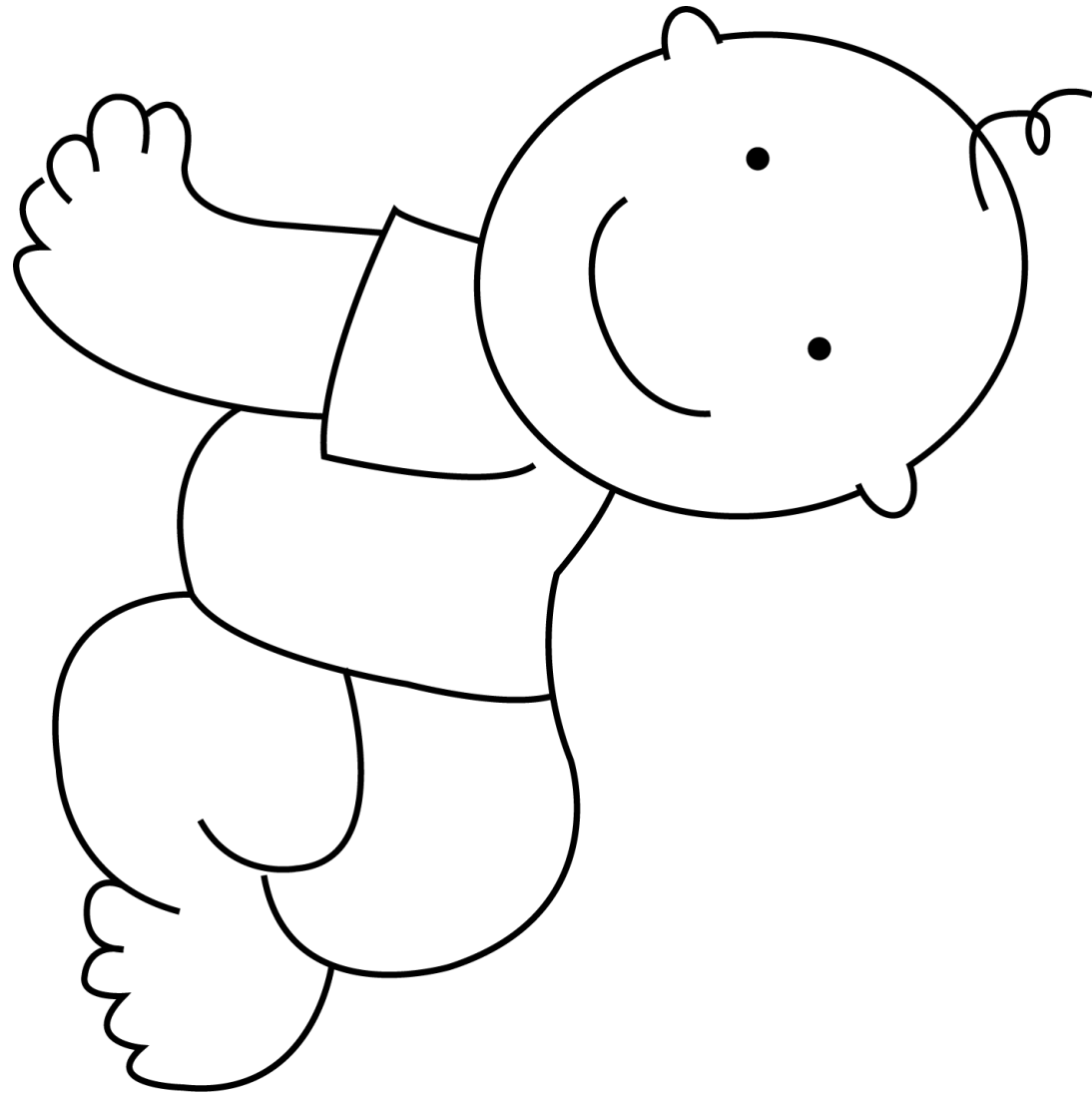

baby

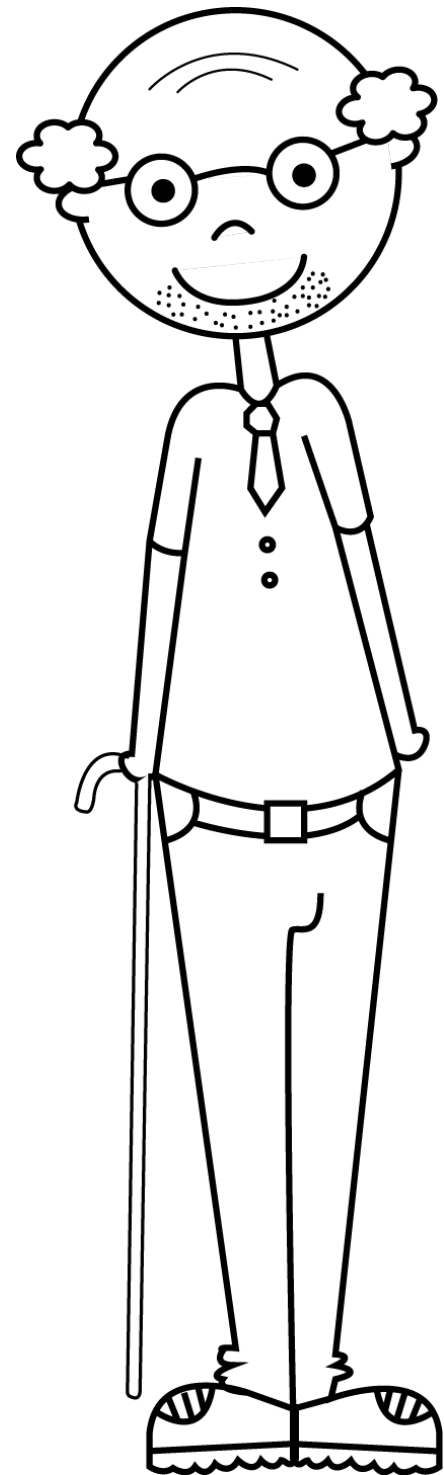
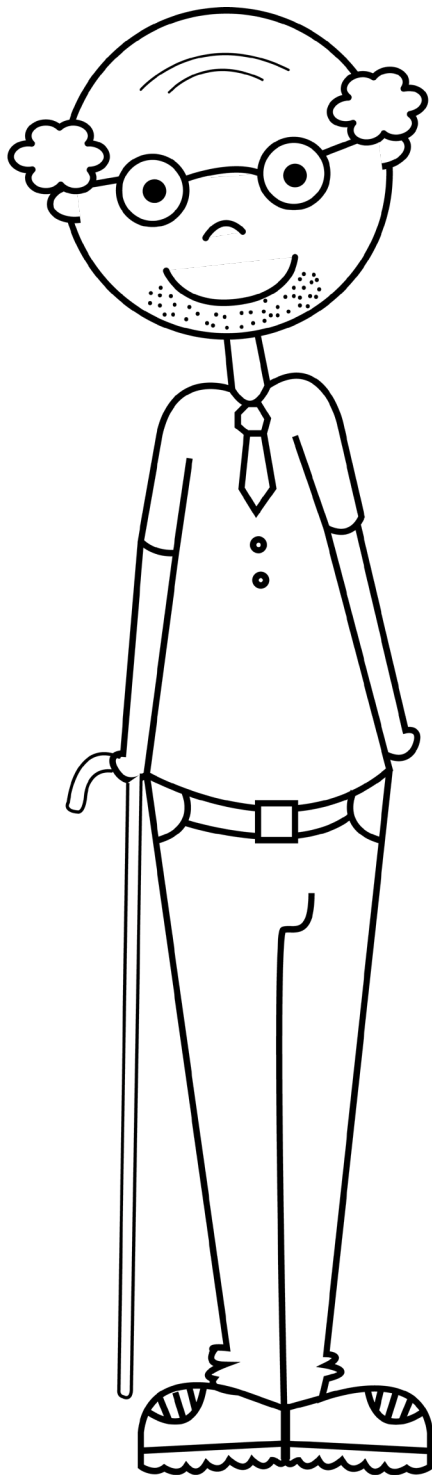
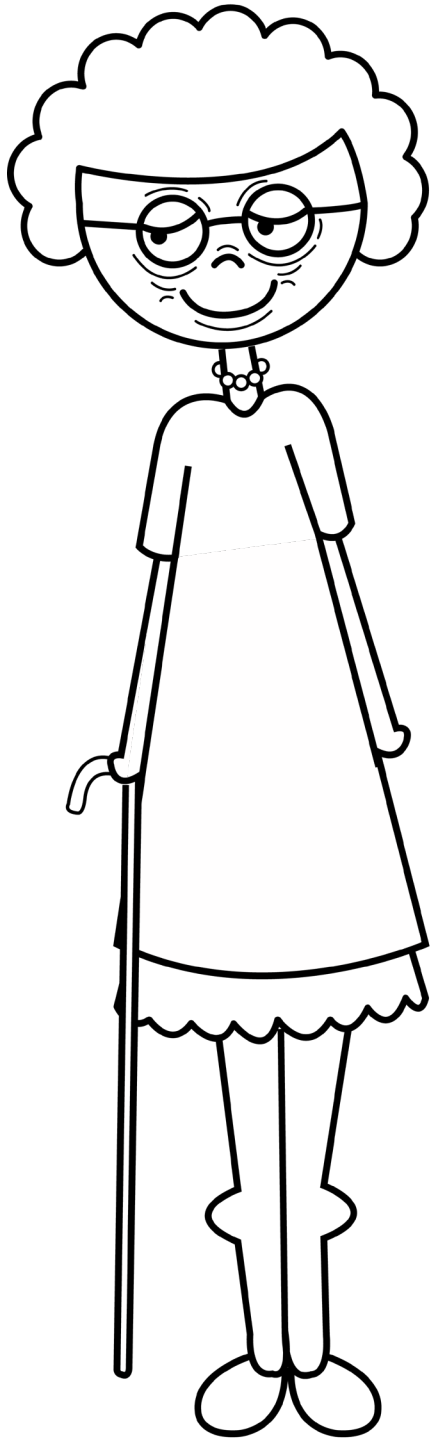

grandparents

grandfather

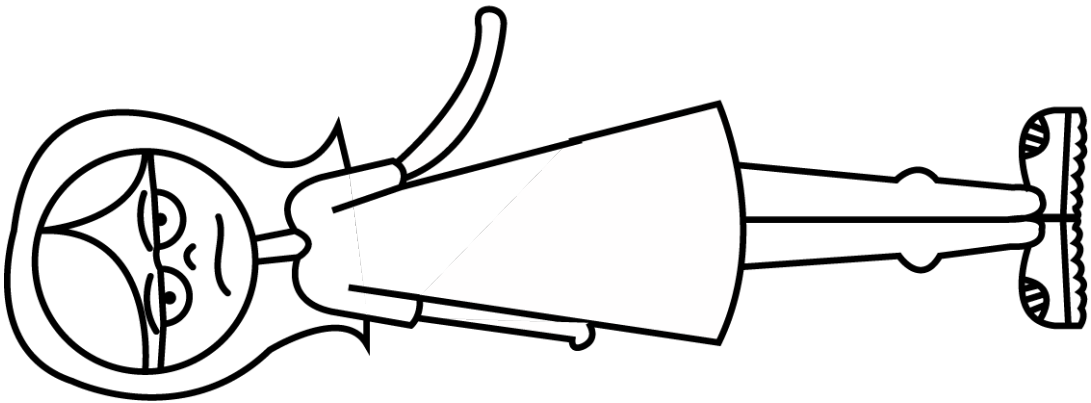
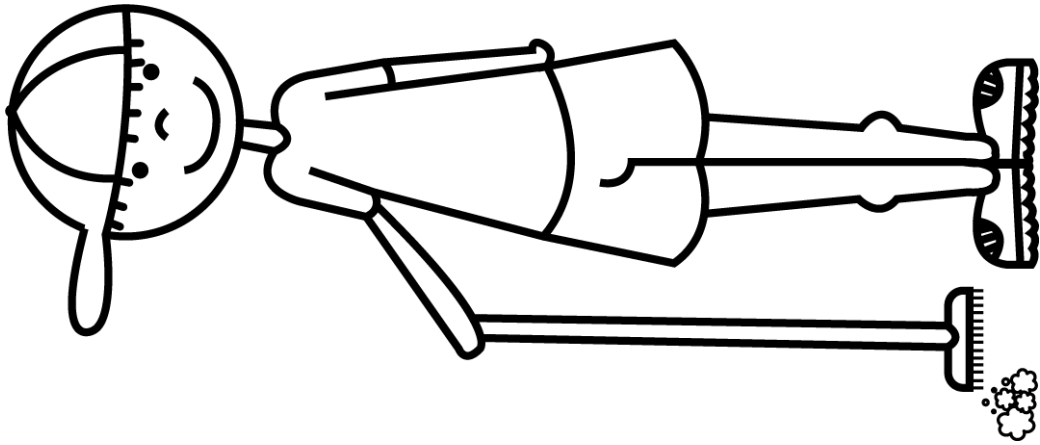
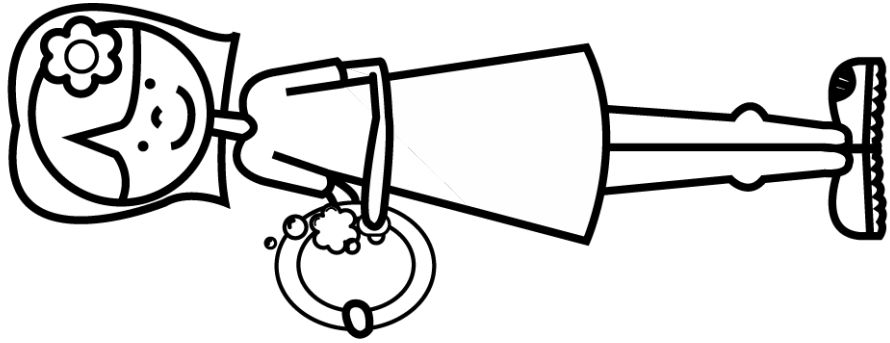

help

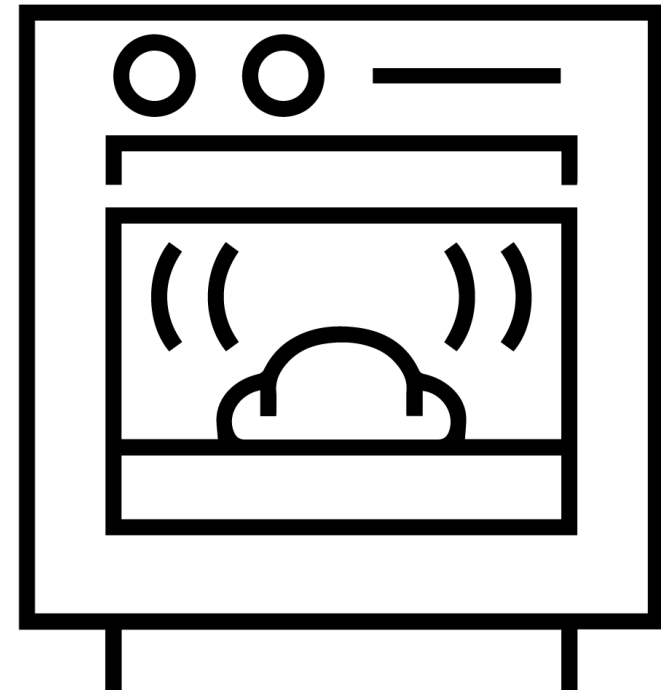
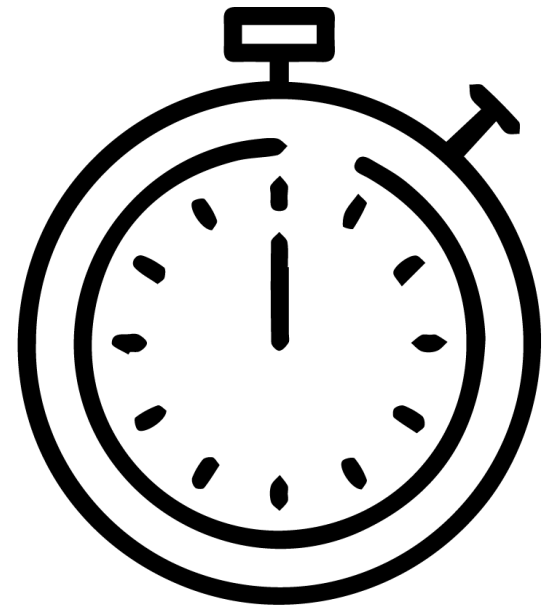
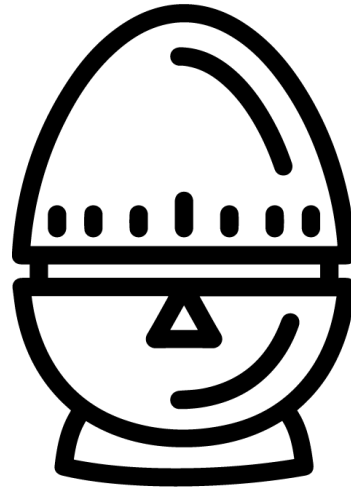

wait

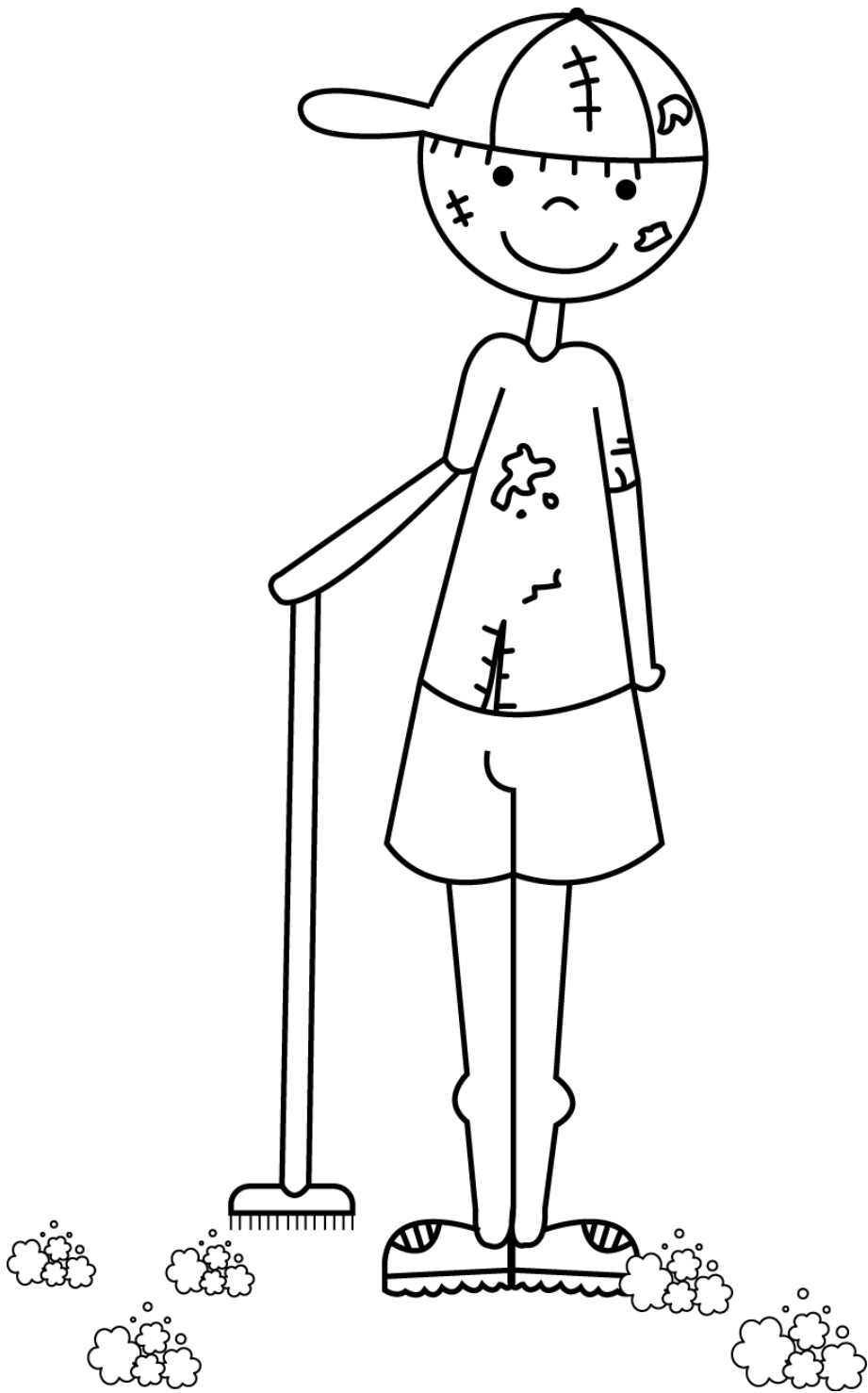

dirty



clean



climb

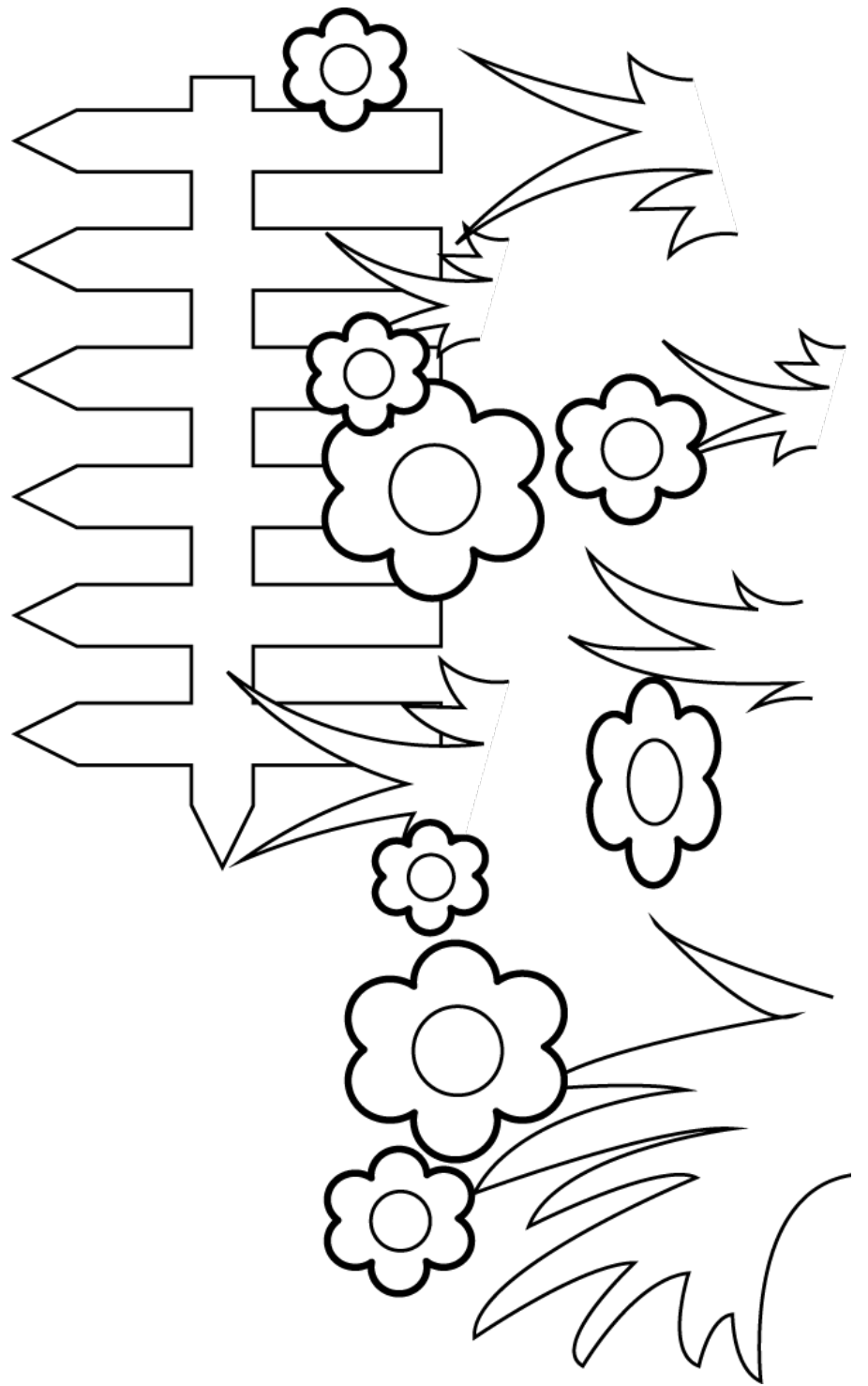

backyard

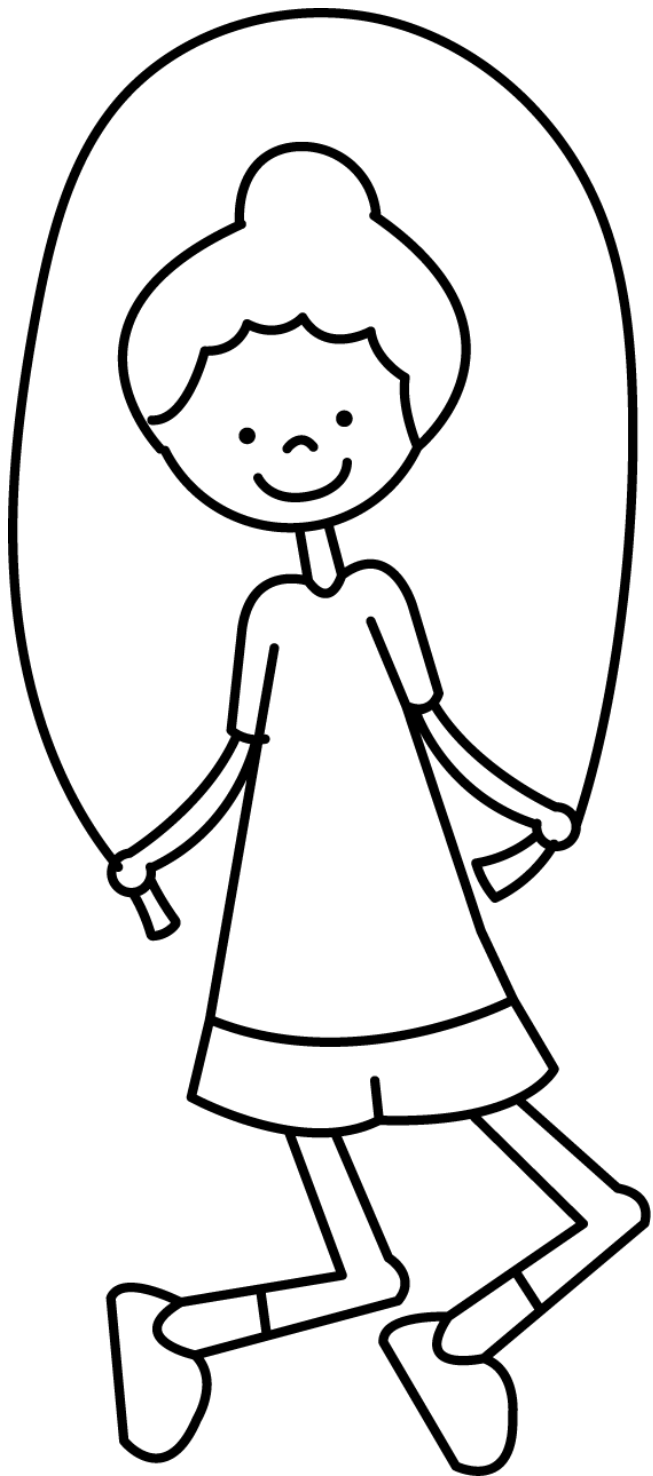

skip

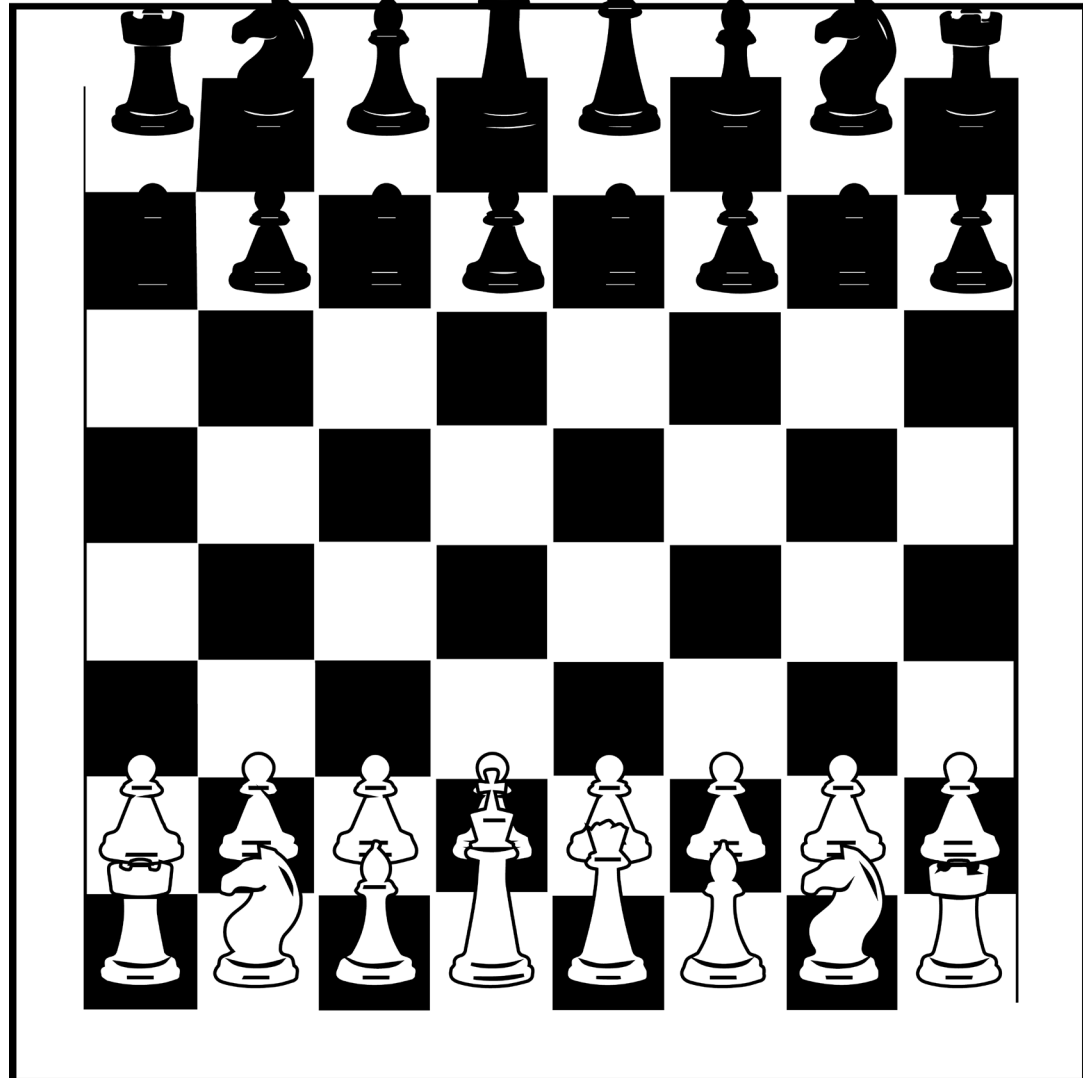

game

3m

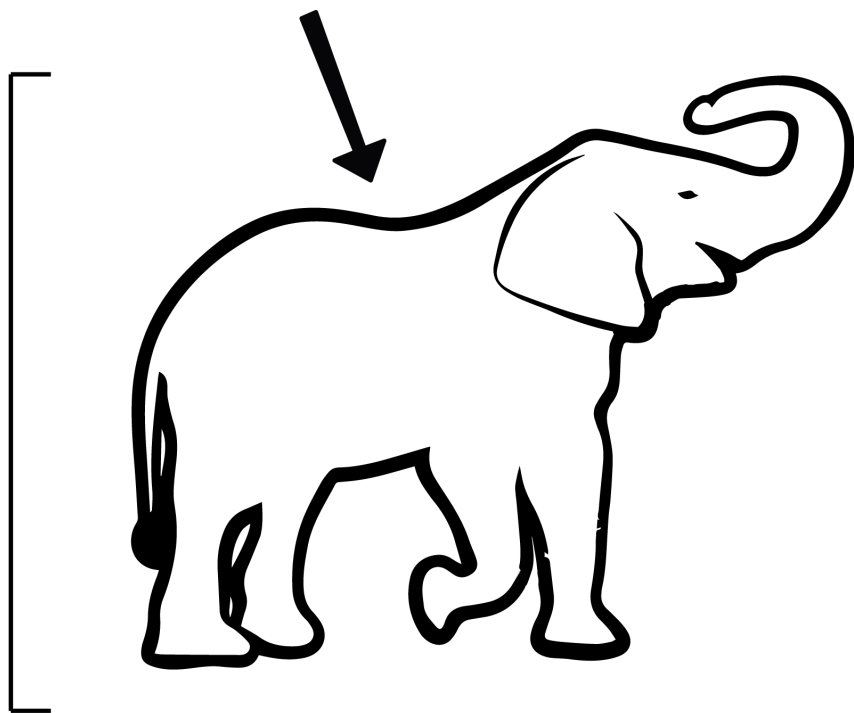

5cm



big

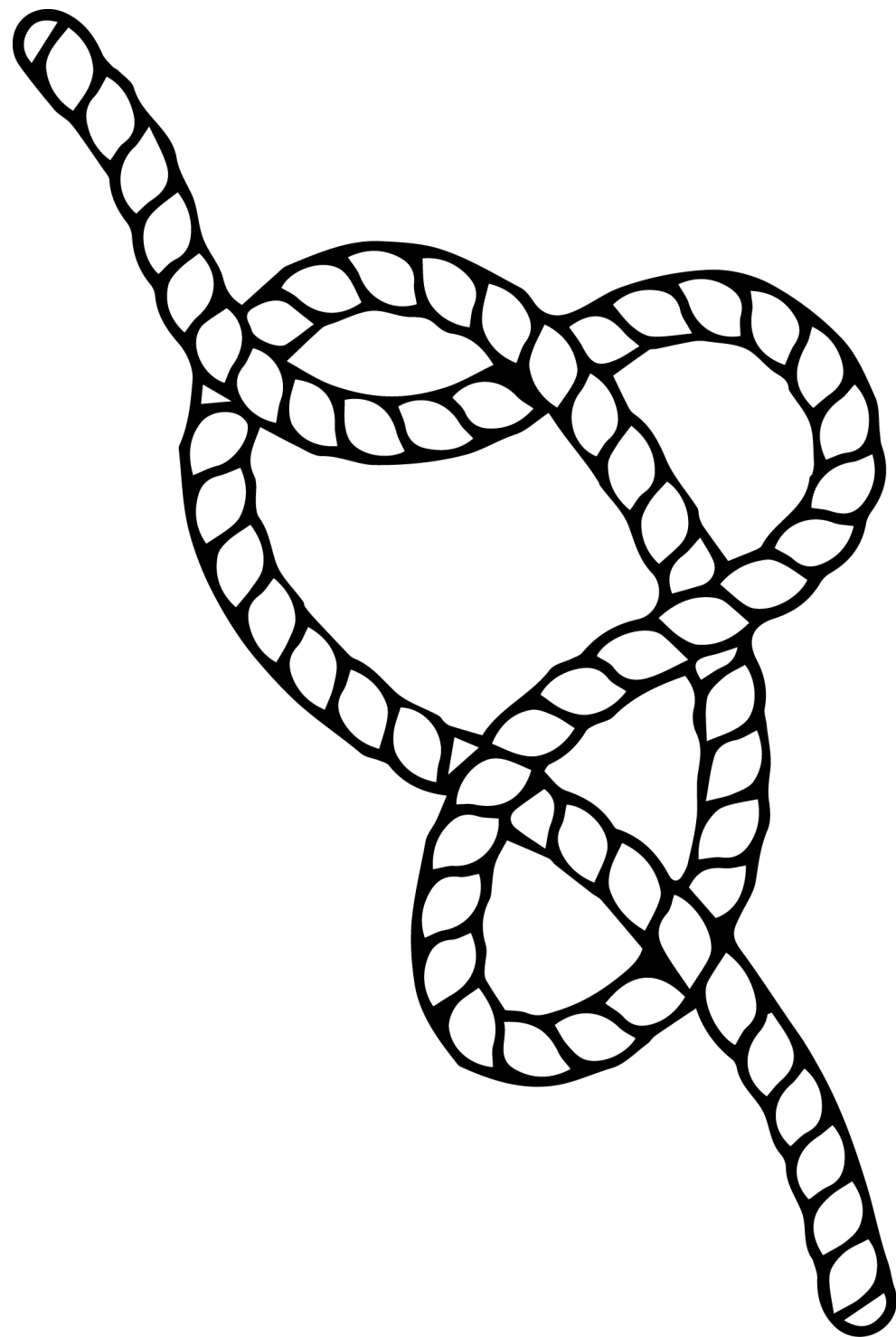

rope

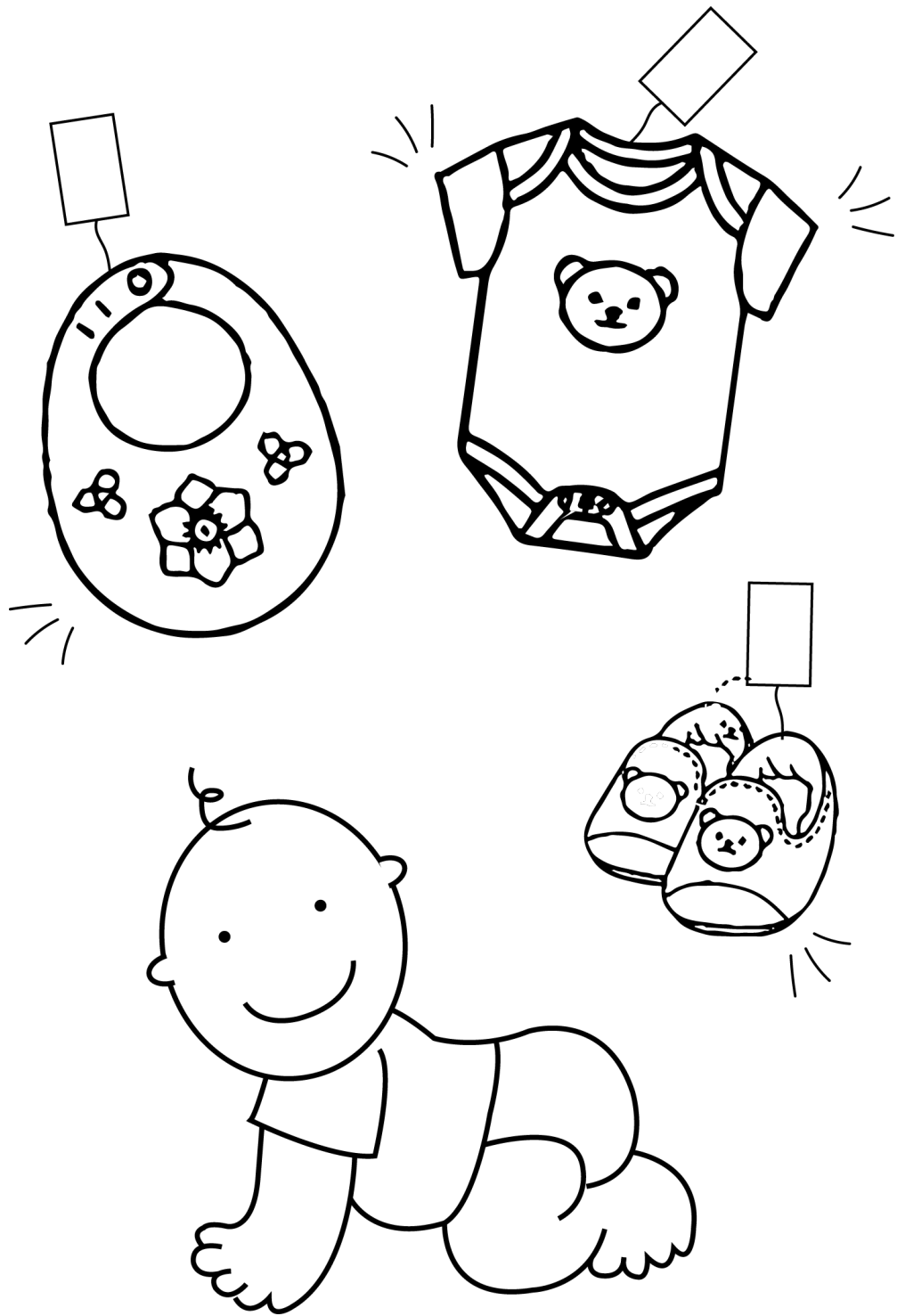

new

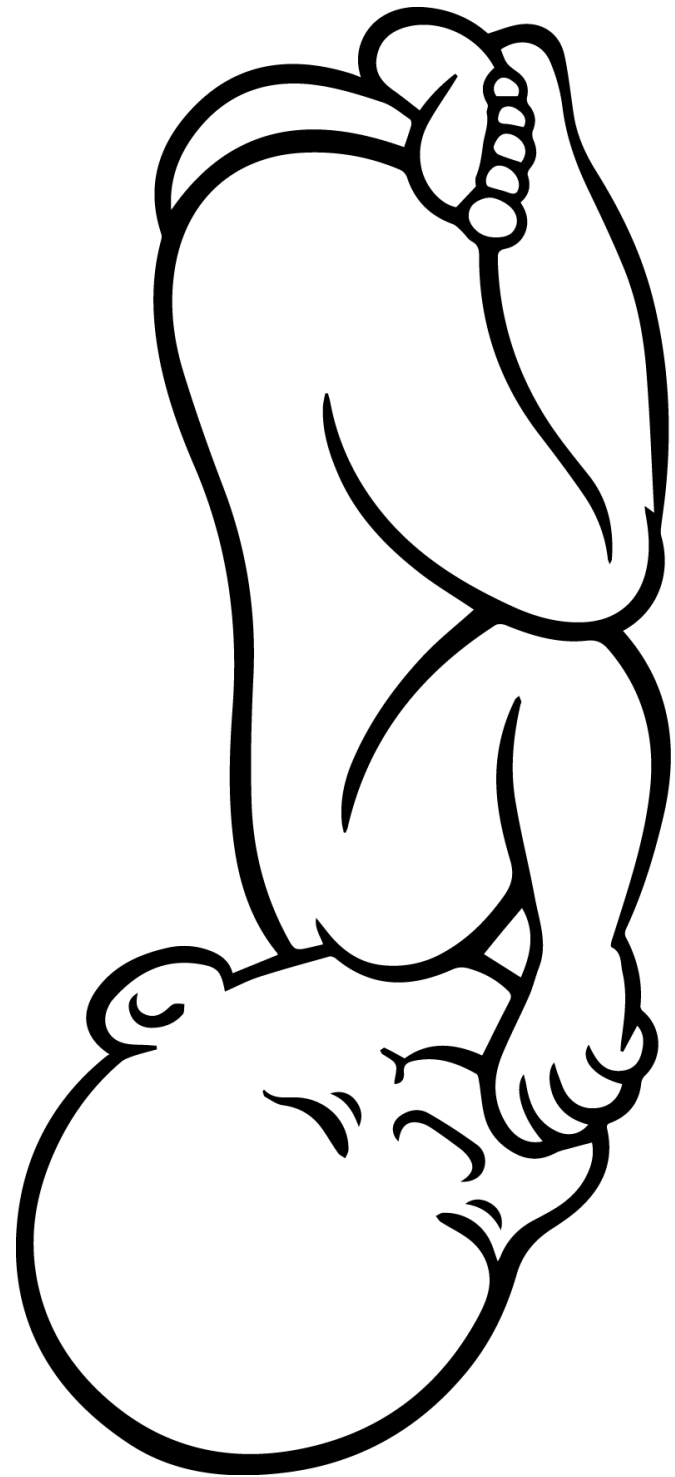

born

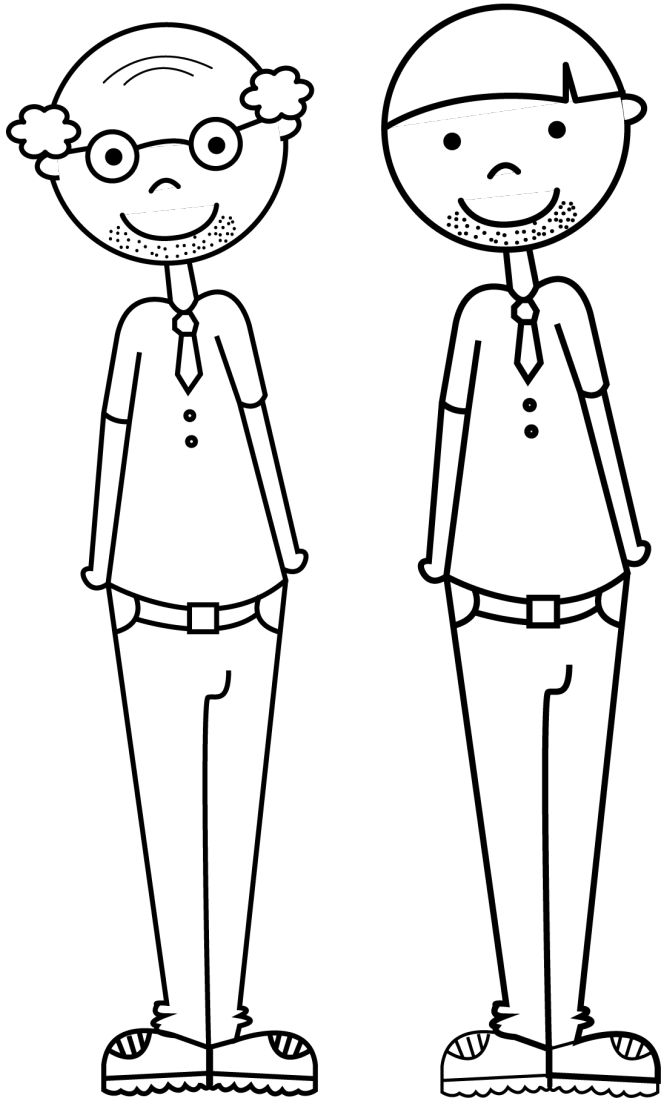
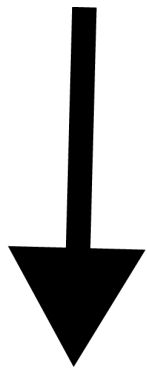

older

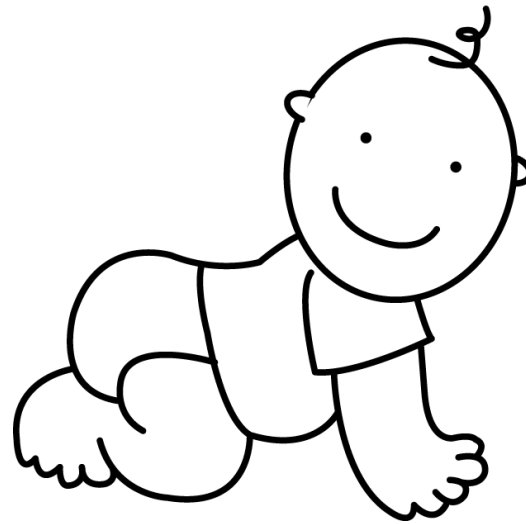
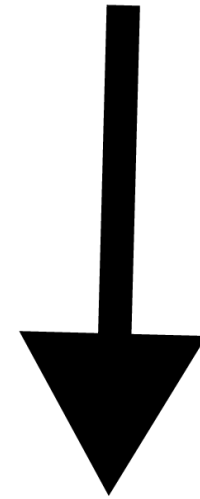

younger

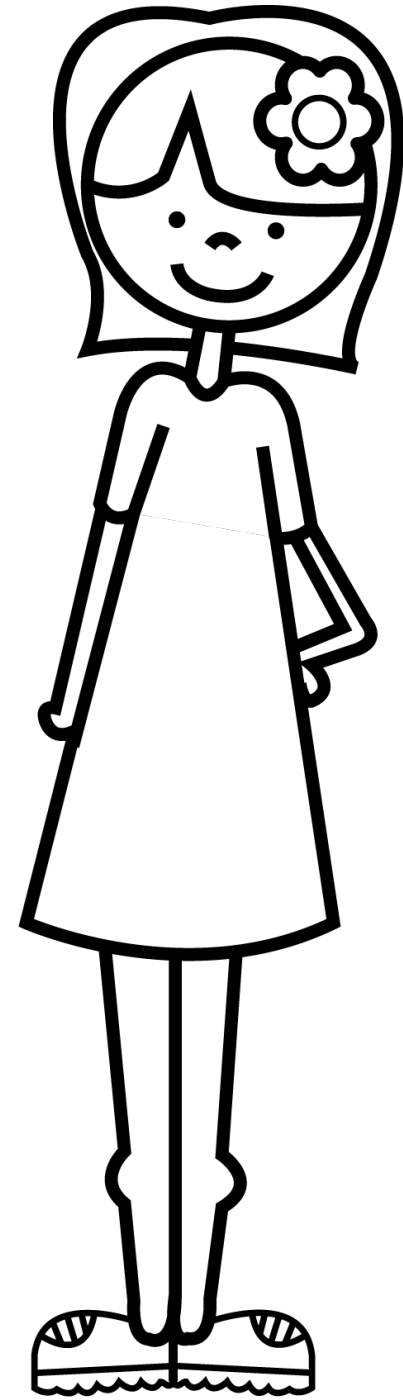



doll

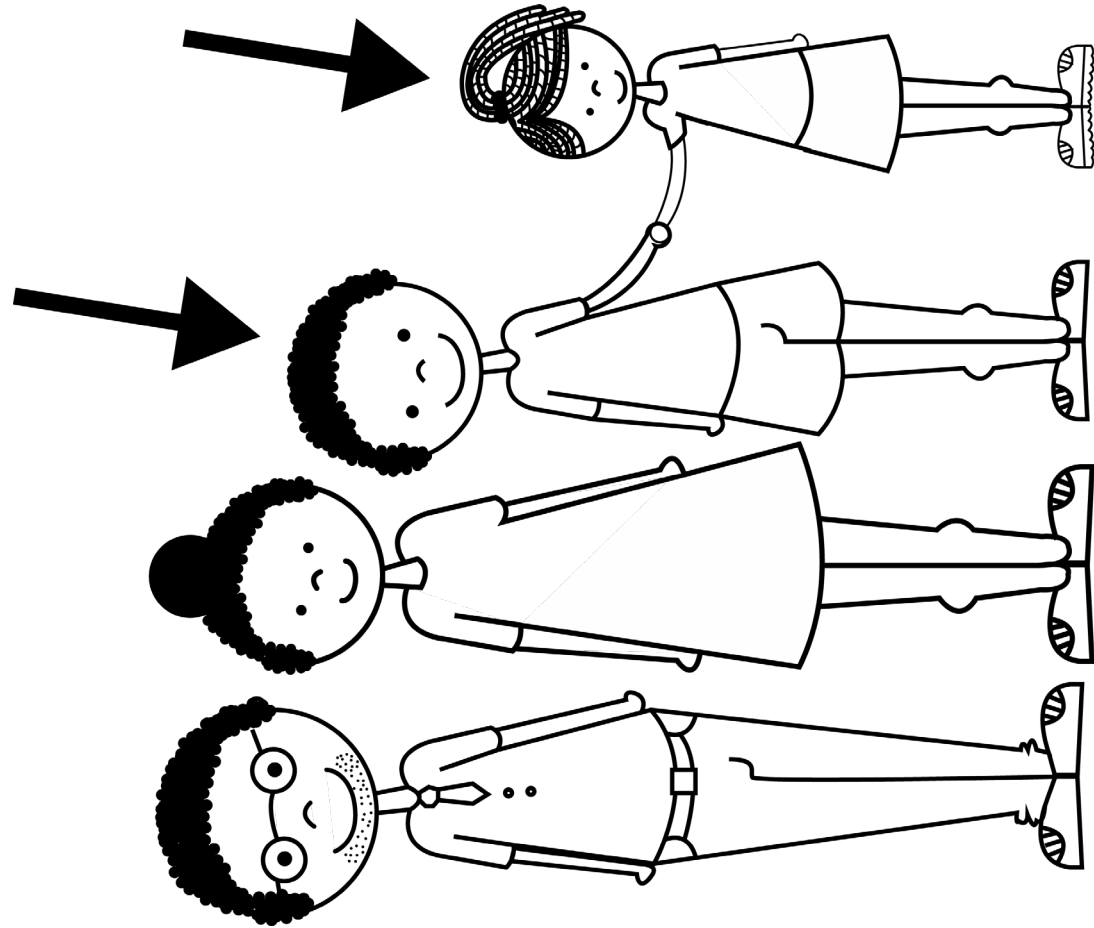

sibling

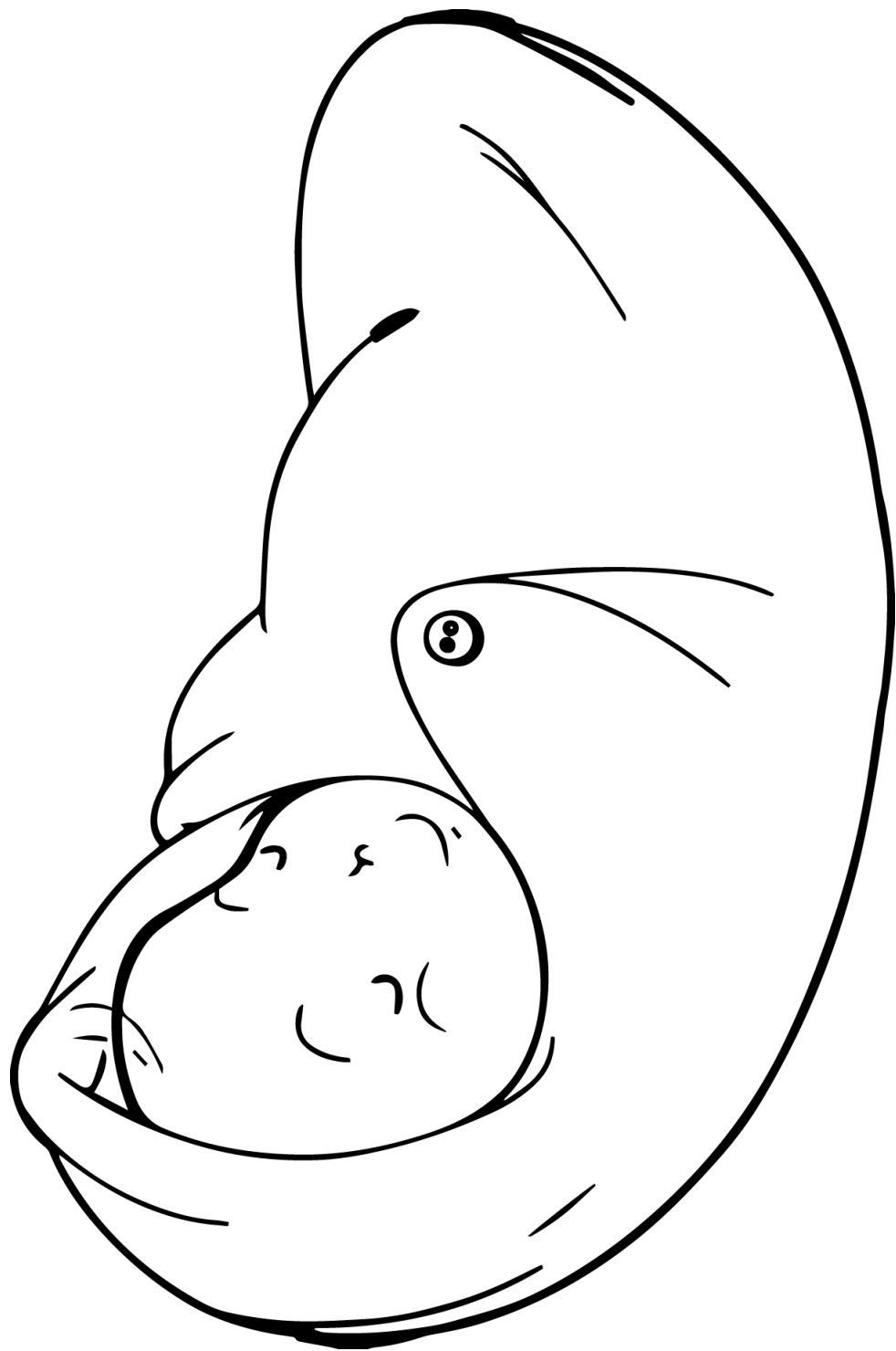

wrap

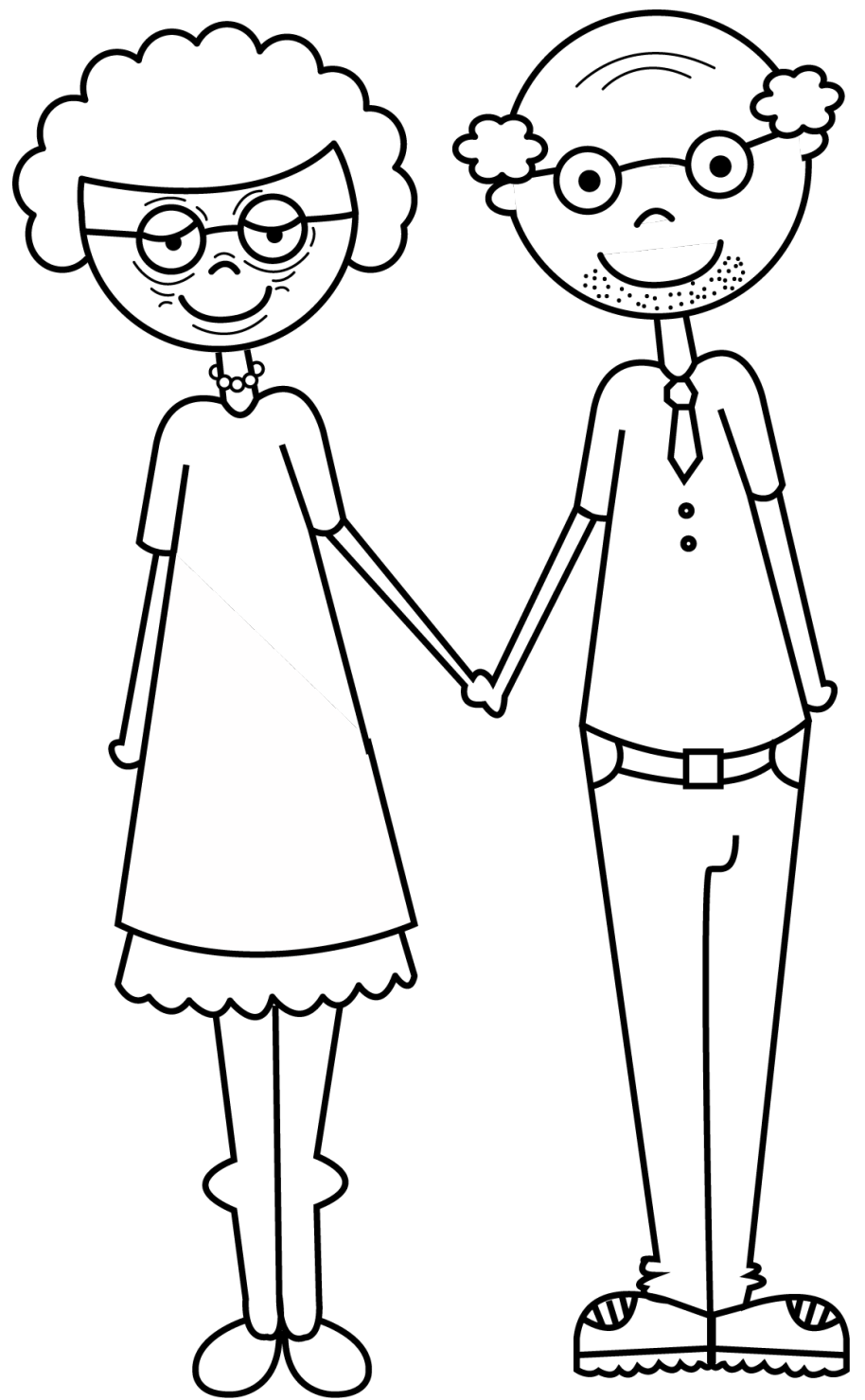

hold

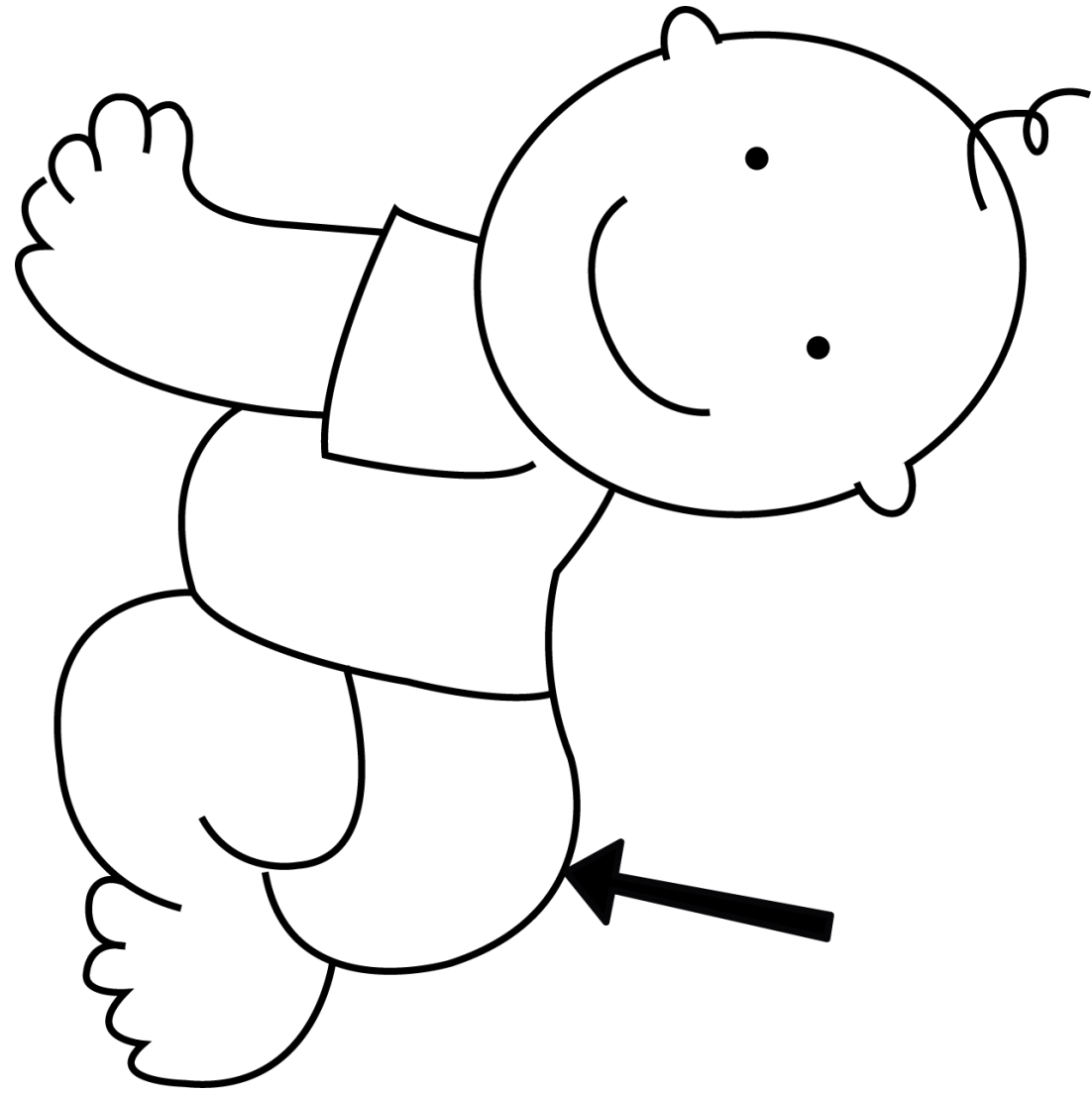

nappy

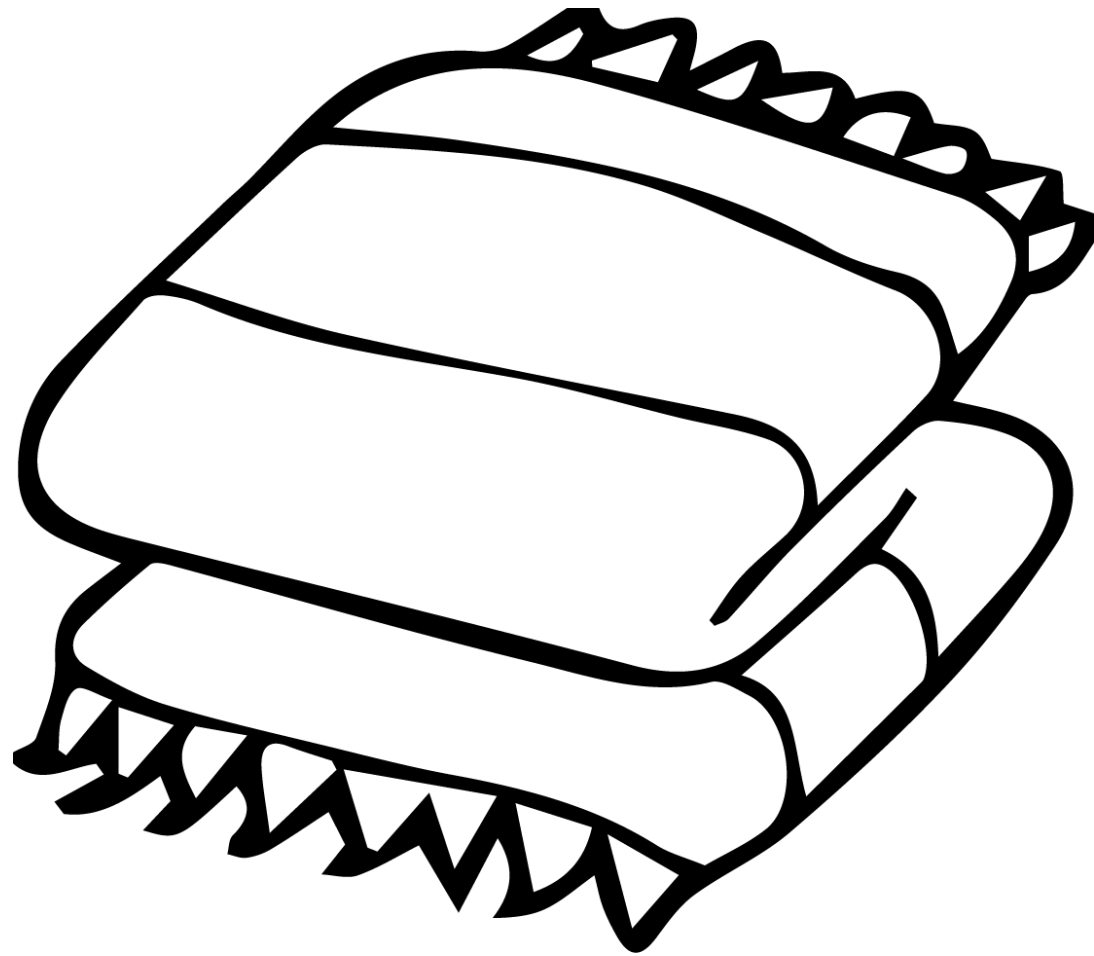

blanket

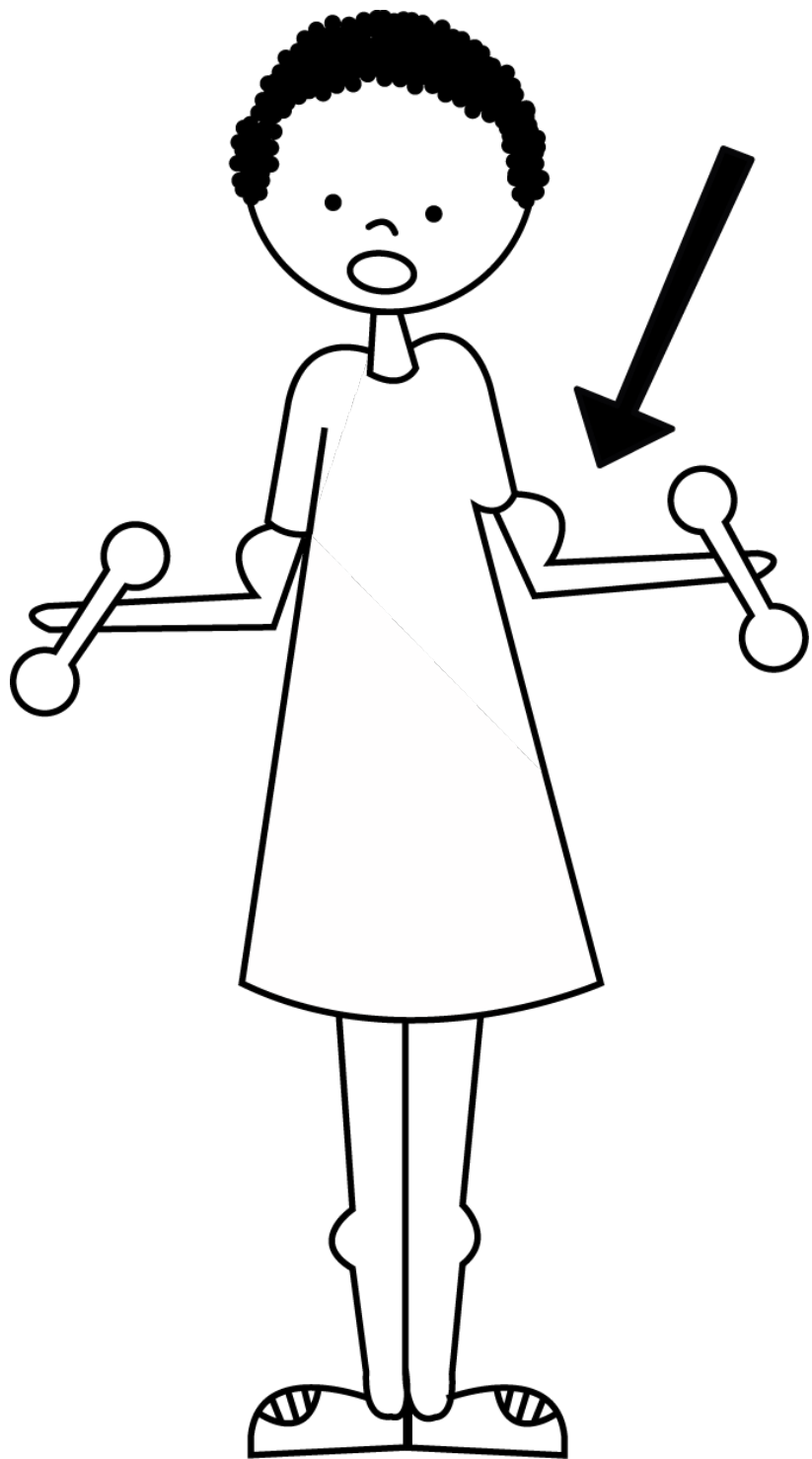

strong

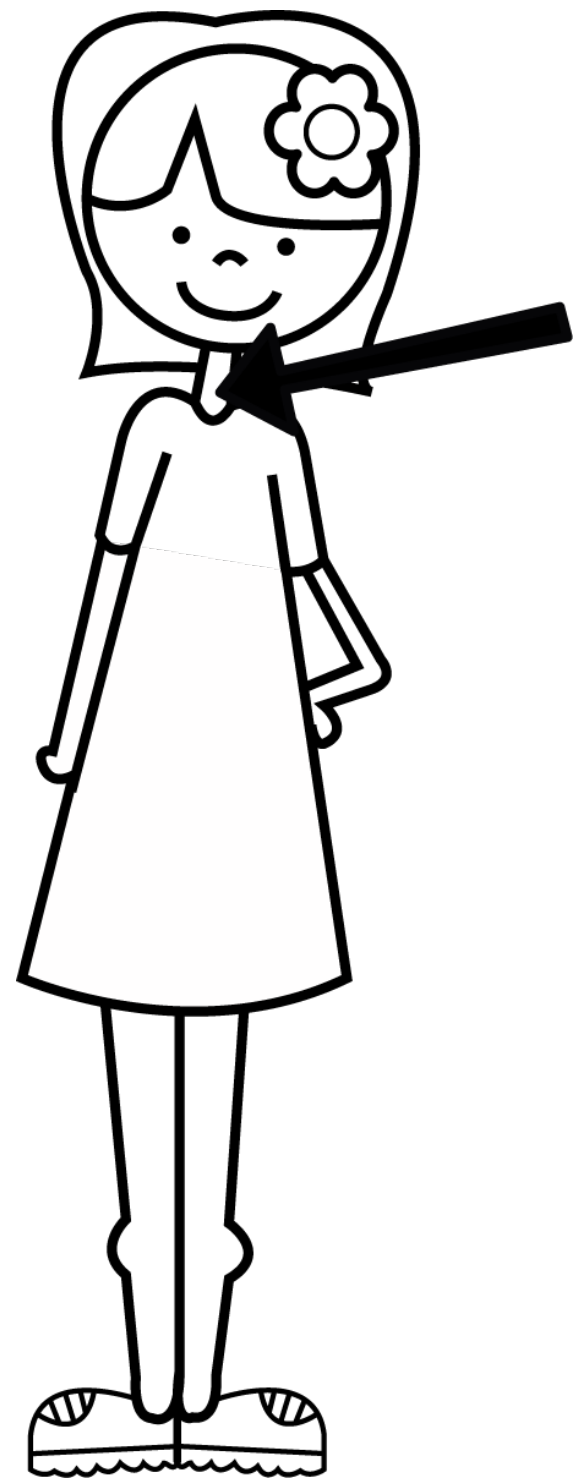

neck

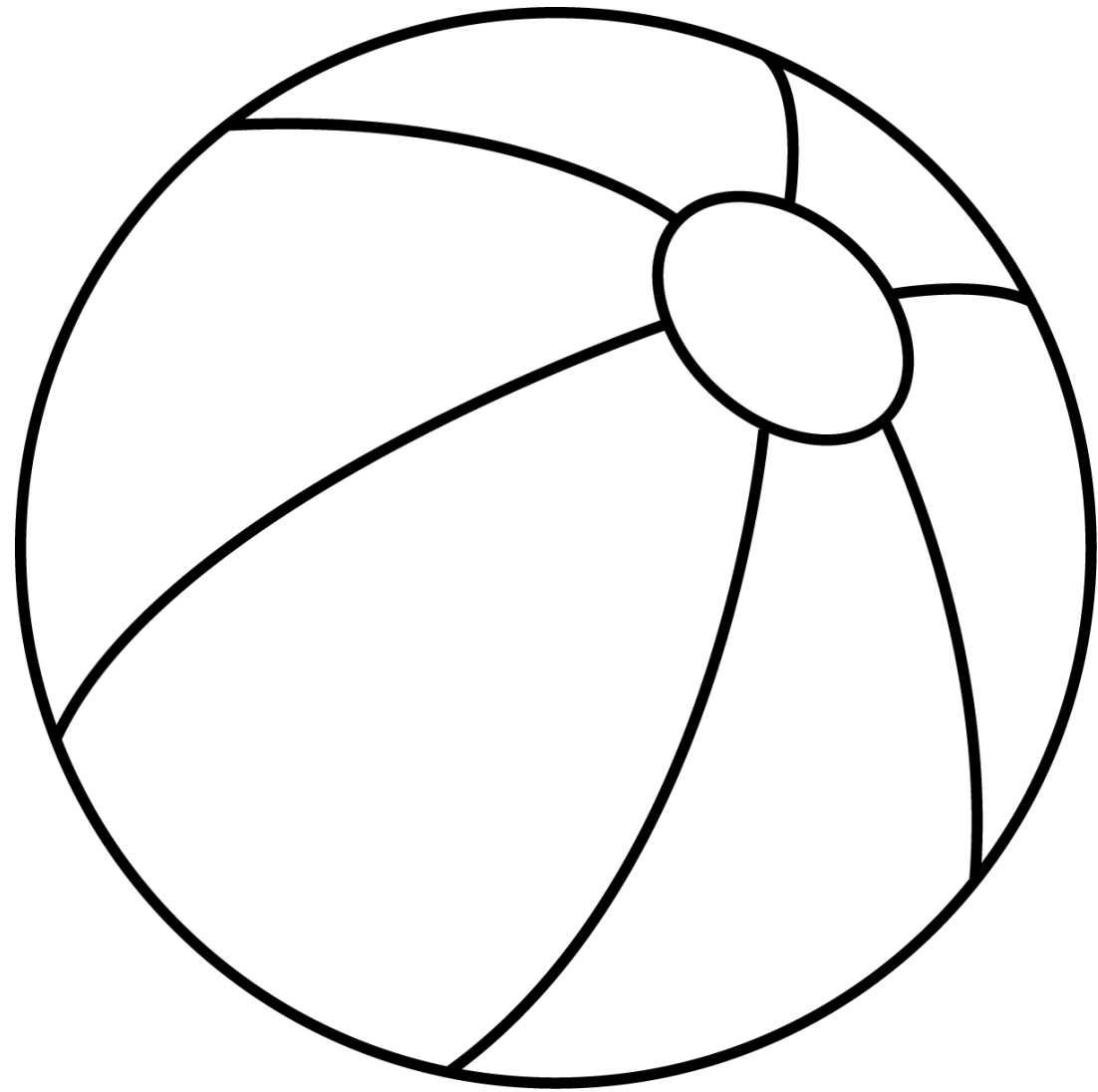

ball

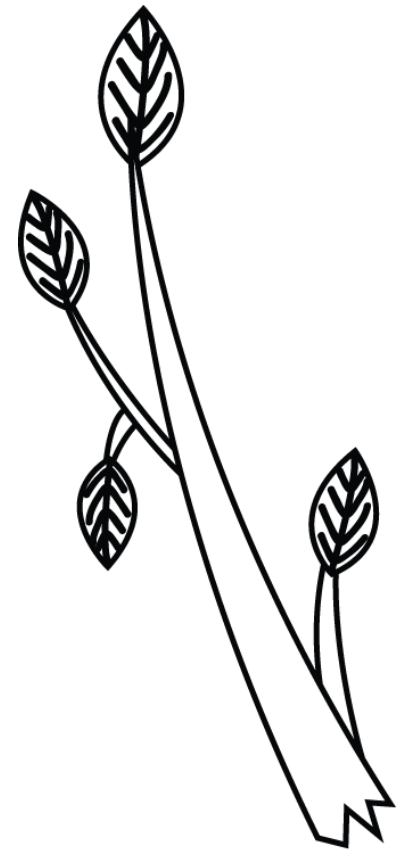

weak

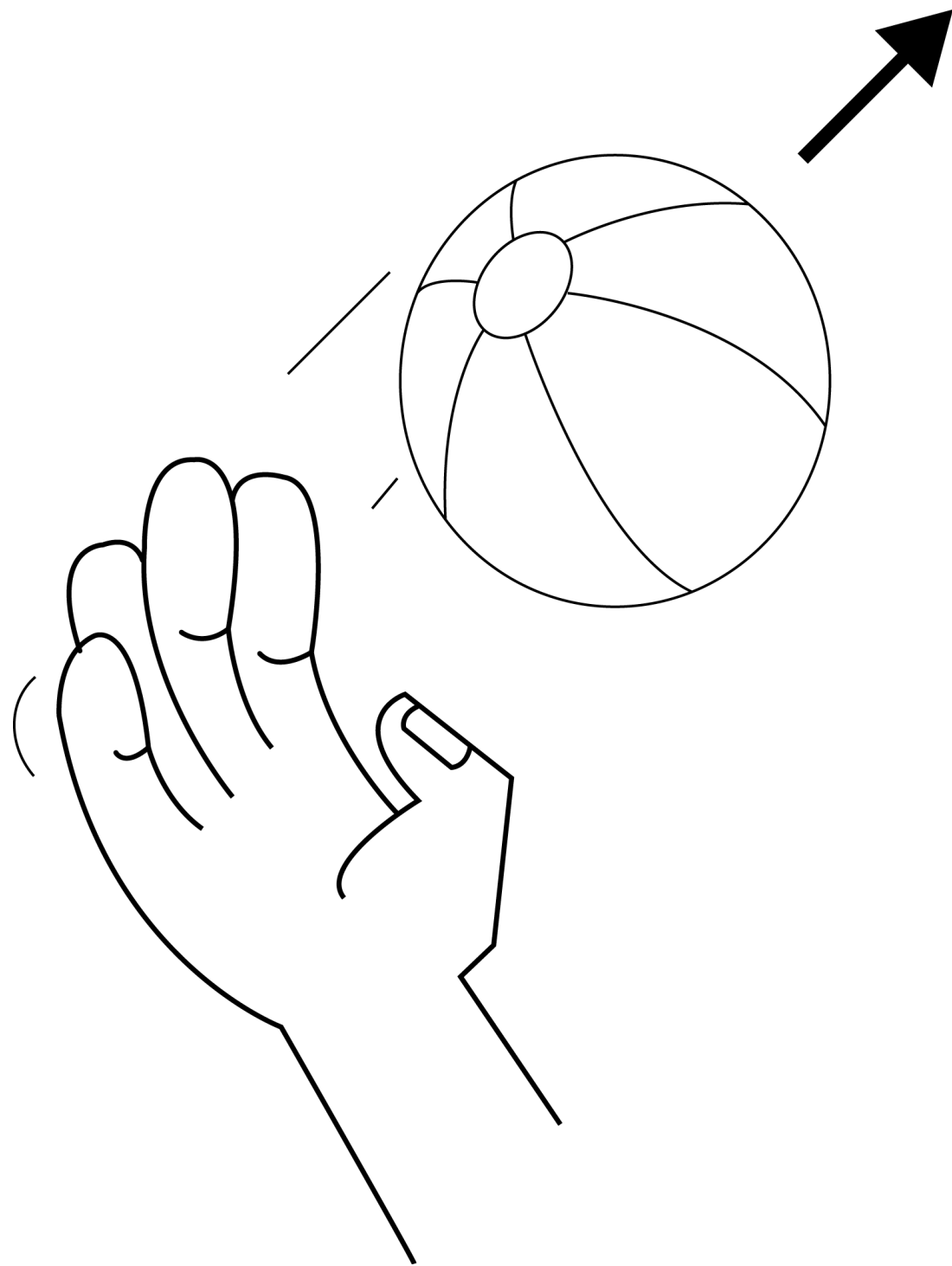

throw

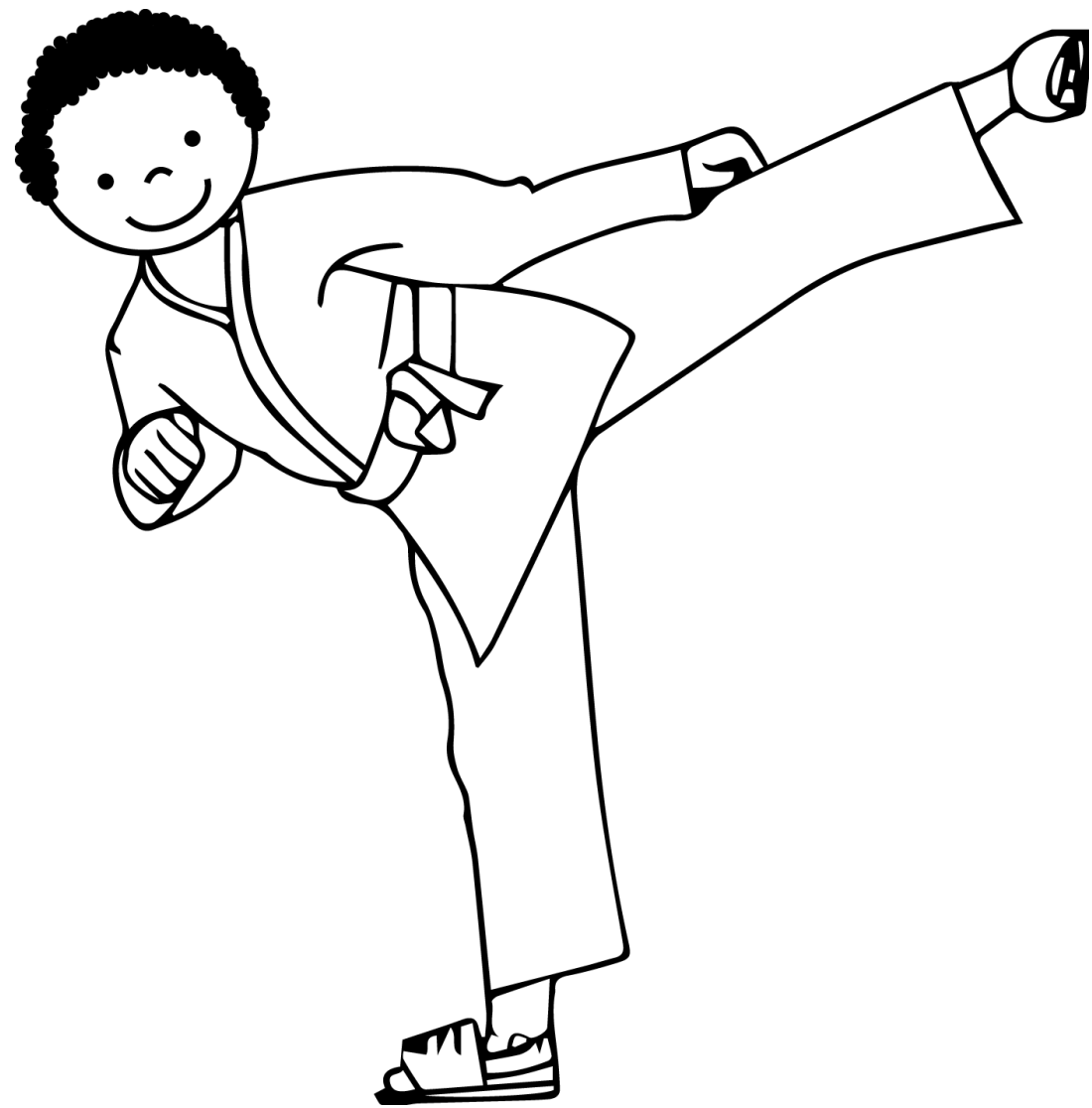

kick

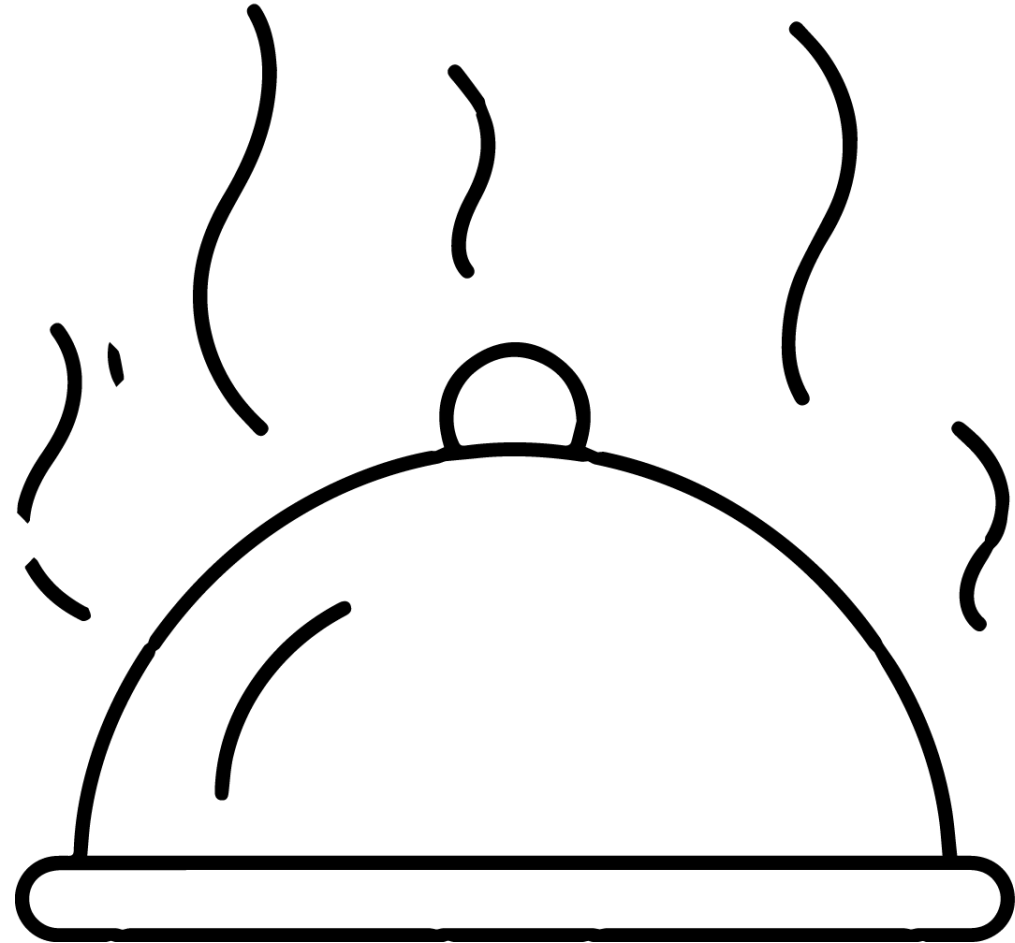
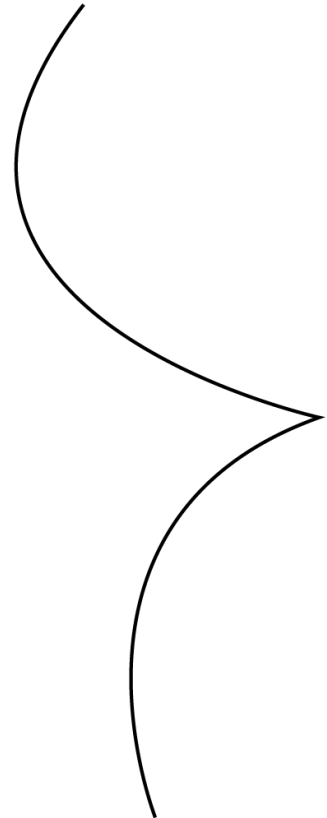
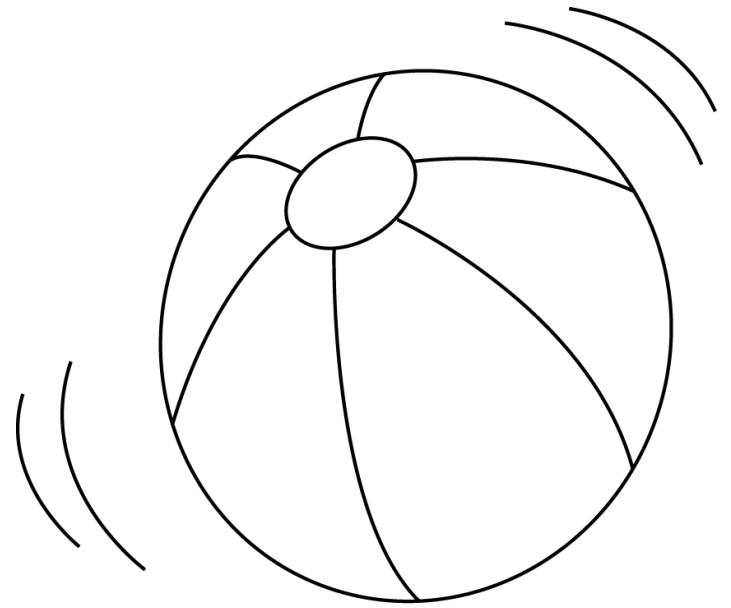
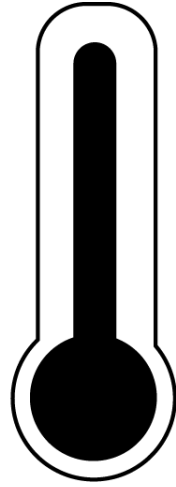

hot

bounce

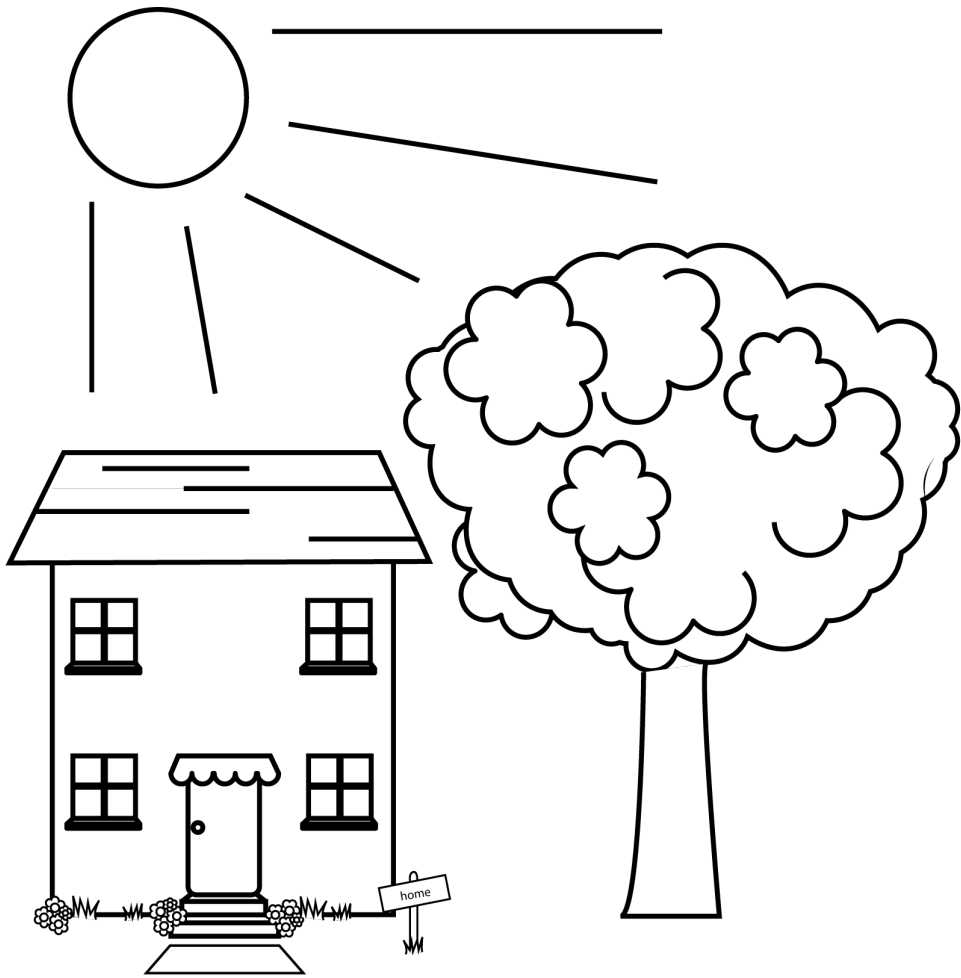

outside



cold



playground

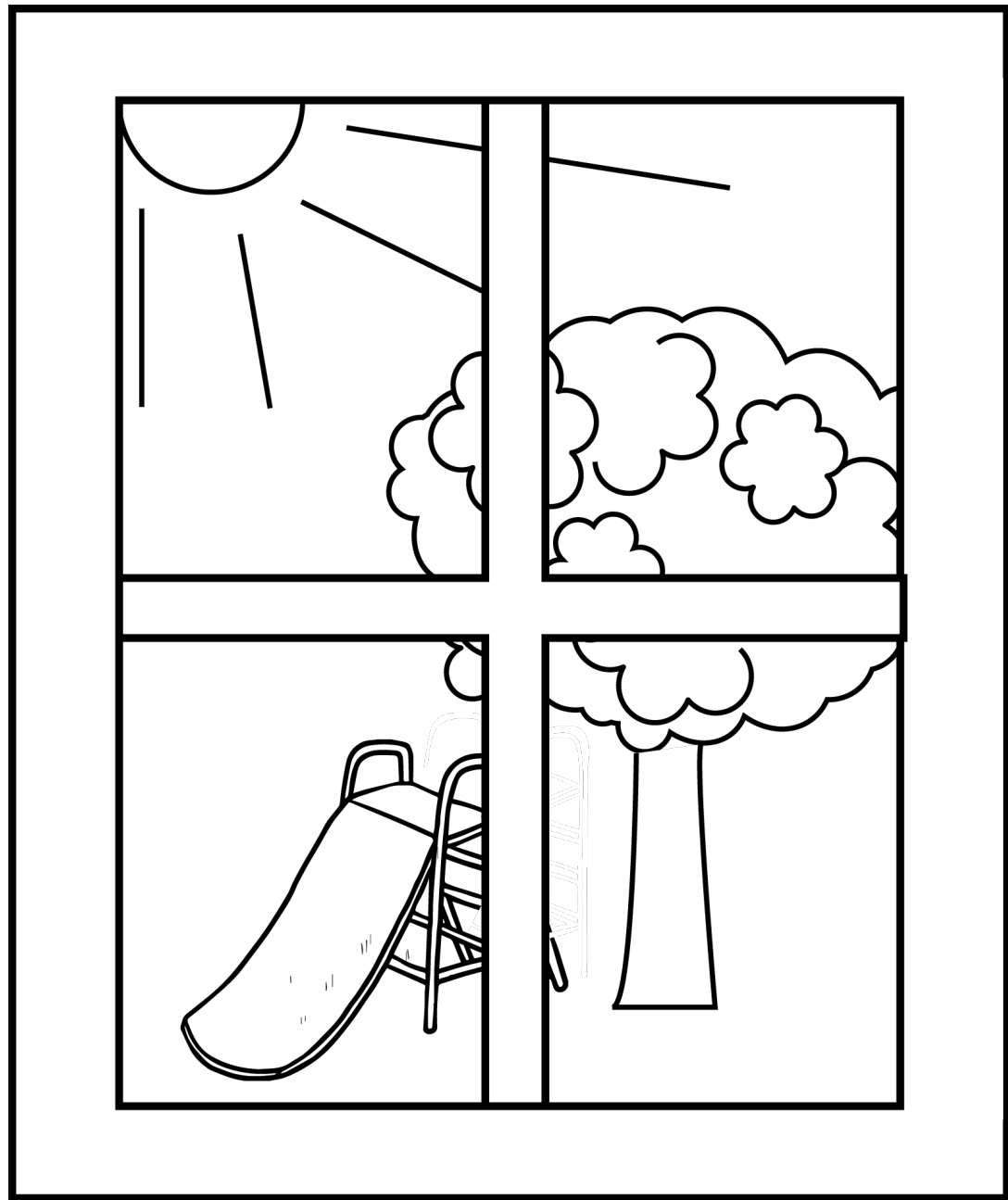

inside

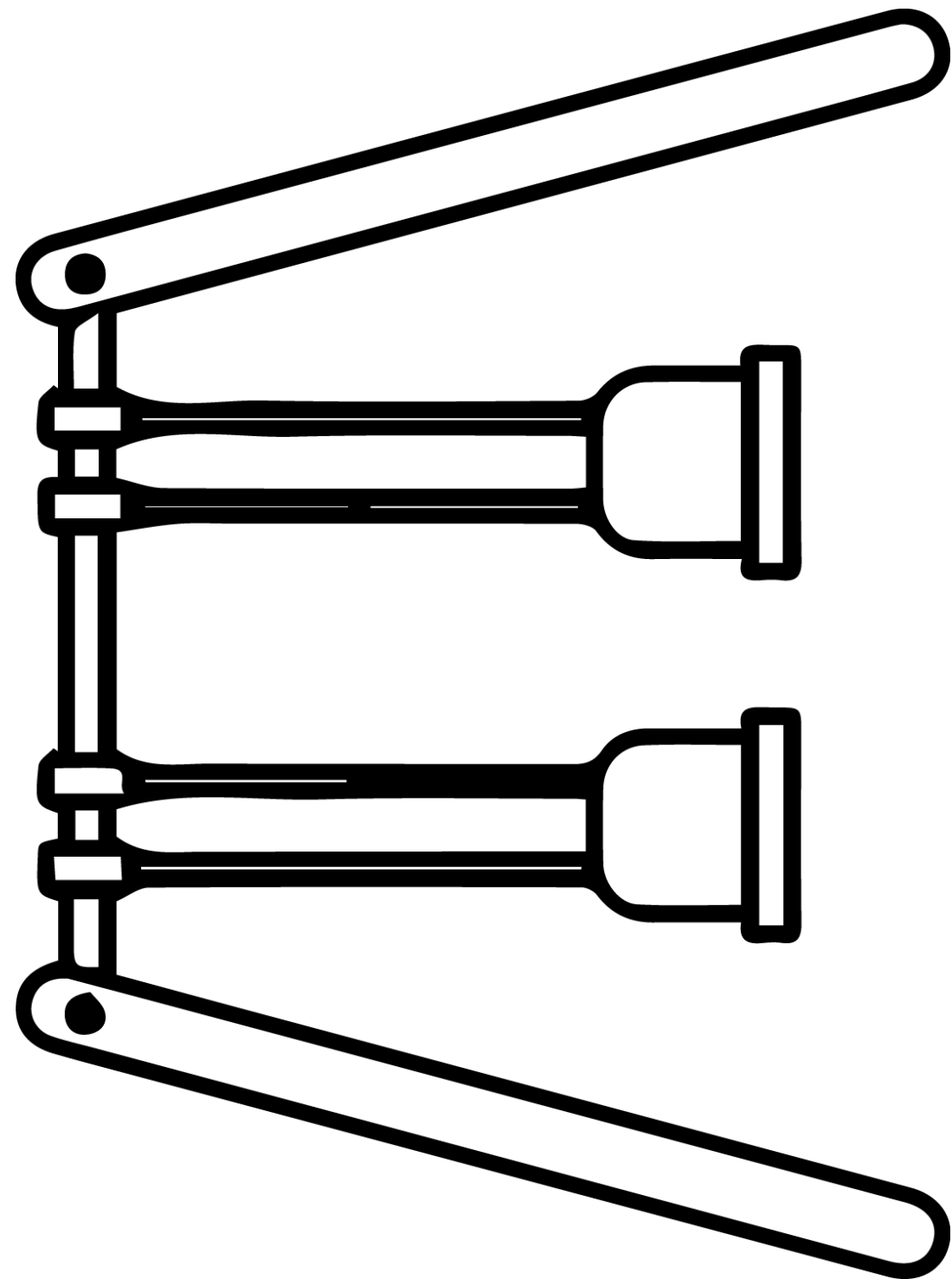

swings



slide



run



down

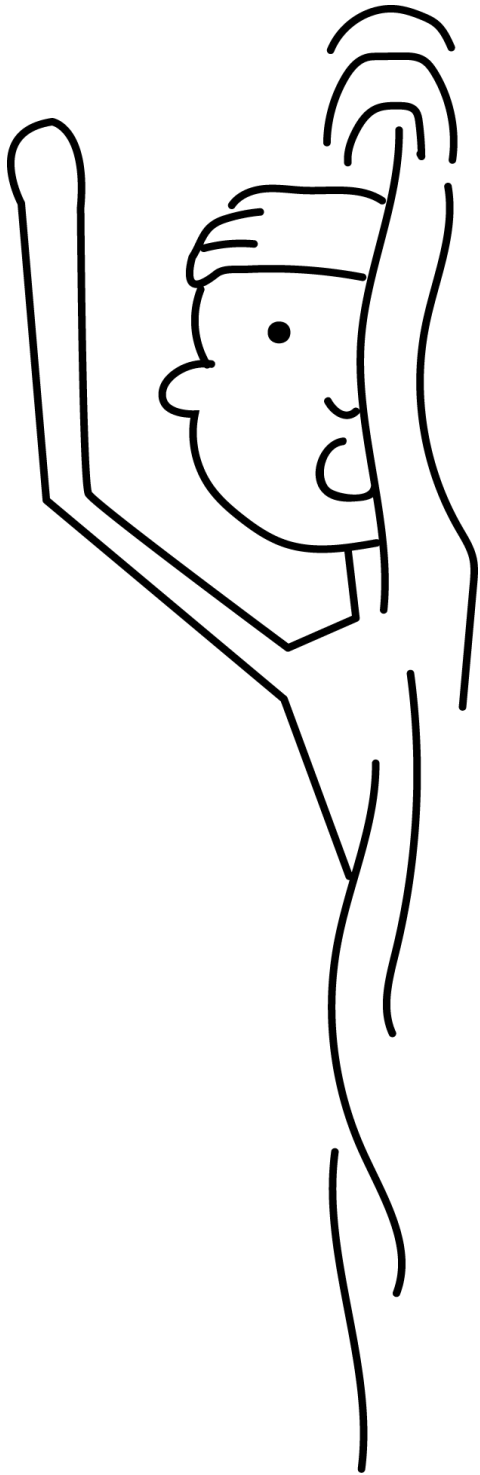

swim



pond

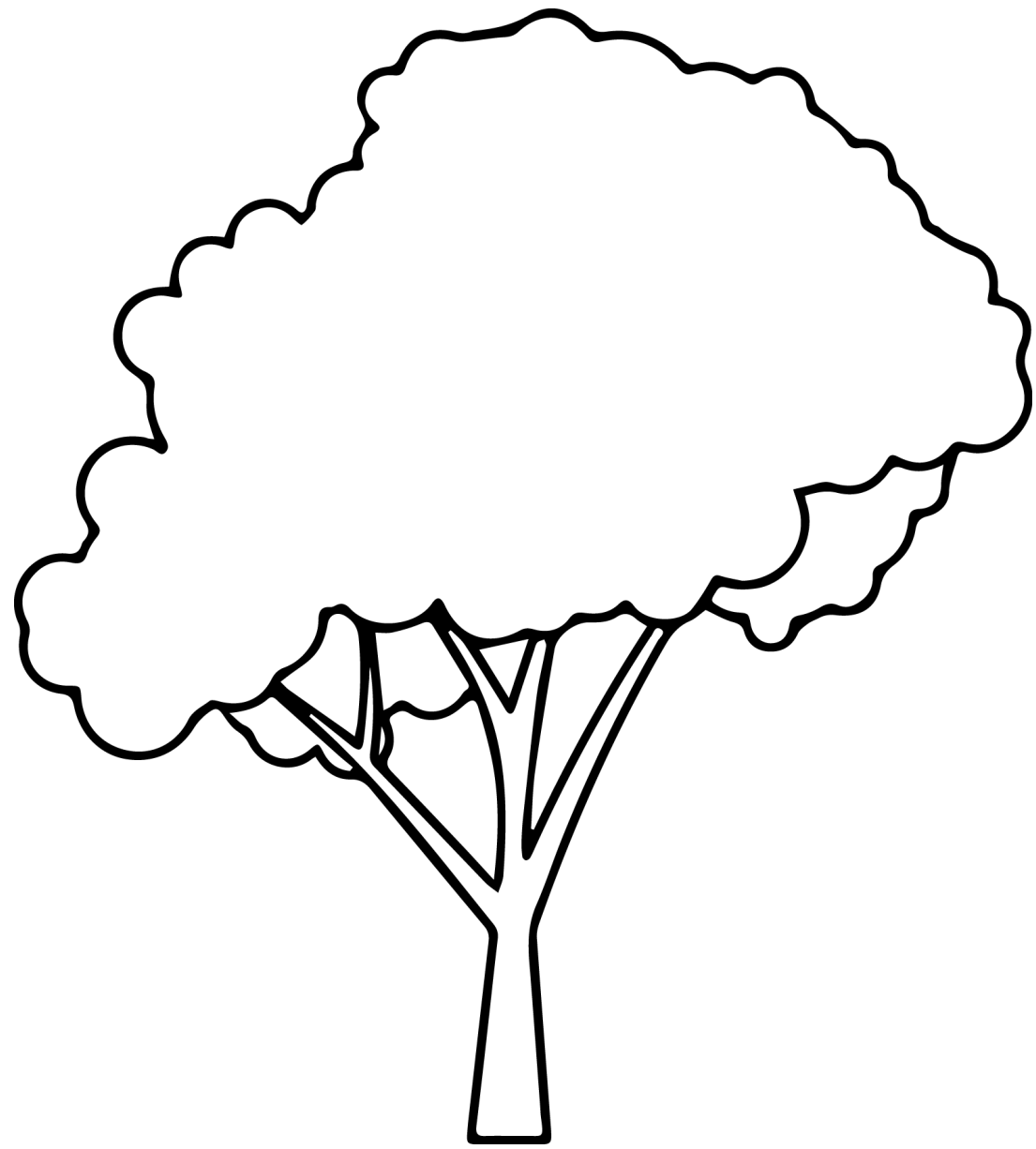

tree

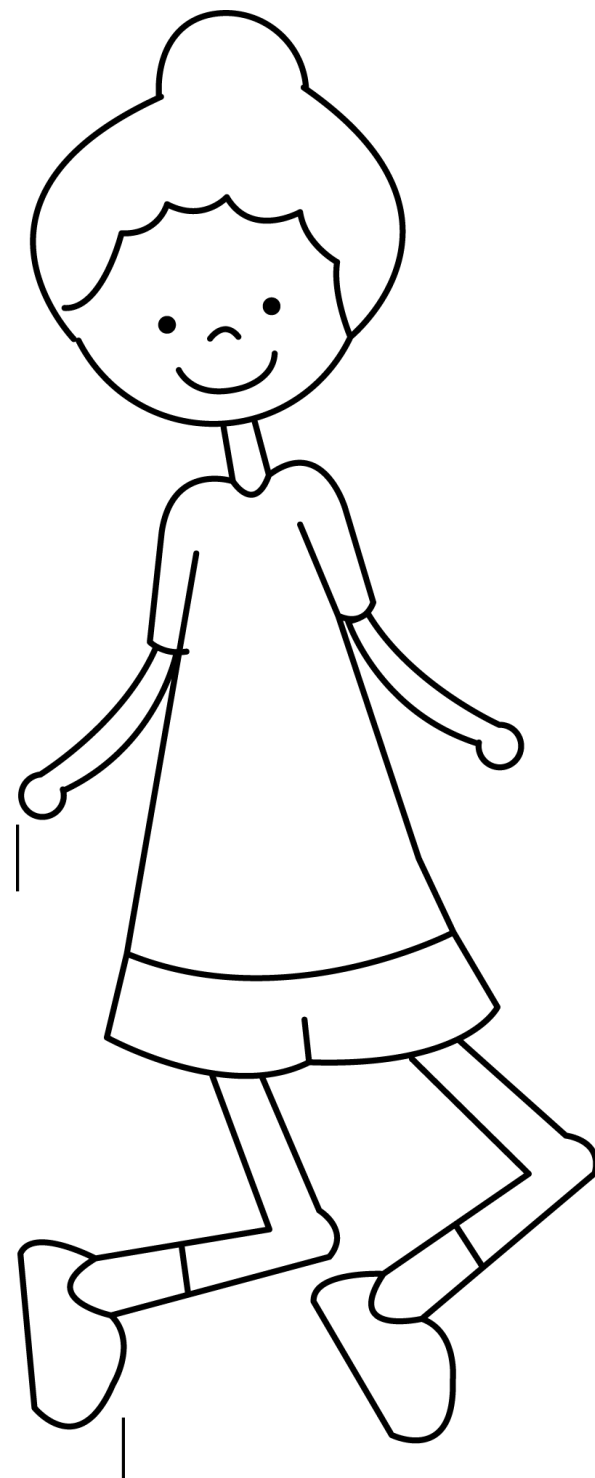

jump

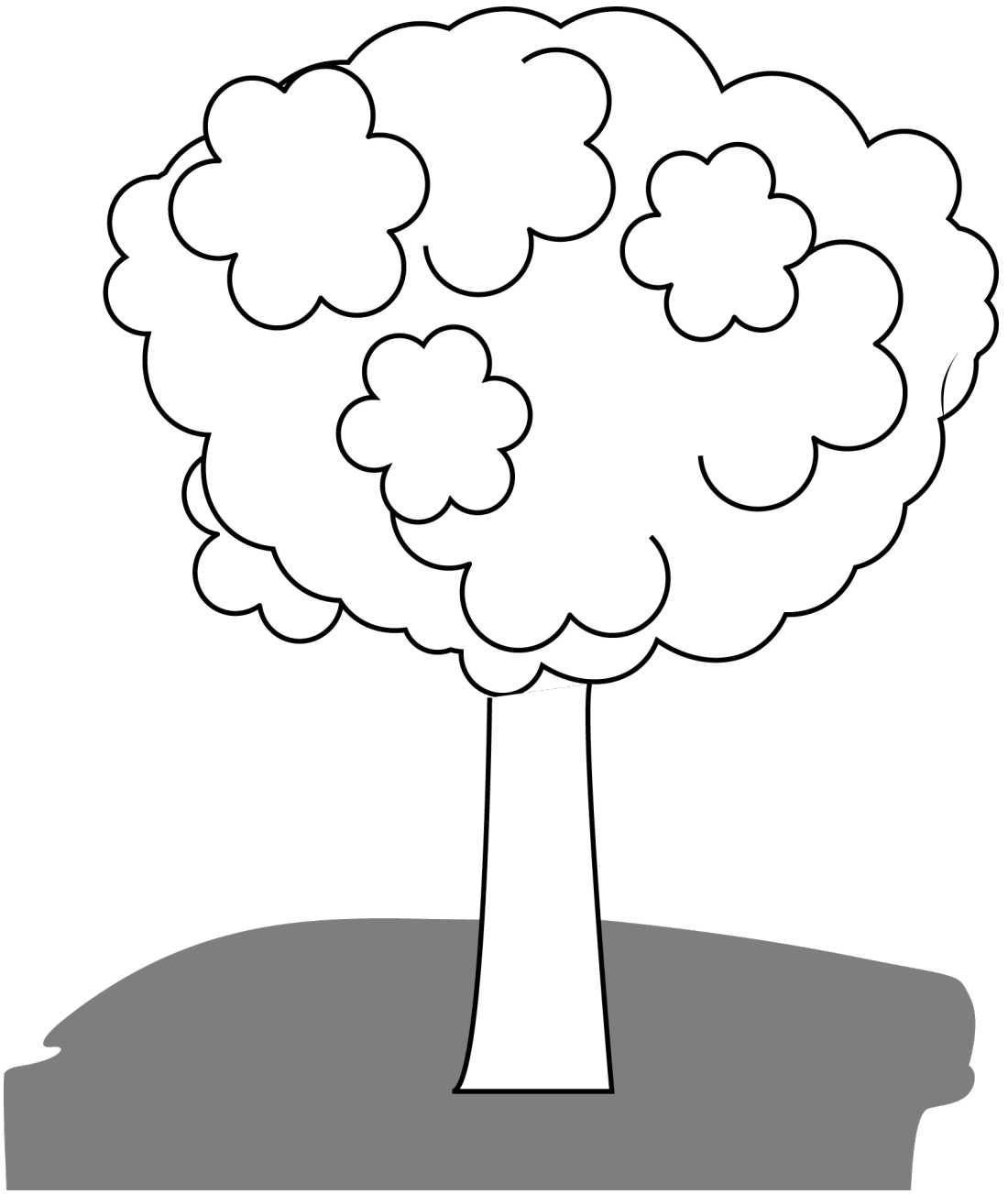

shade

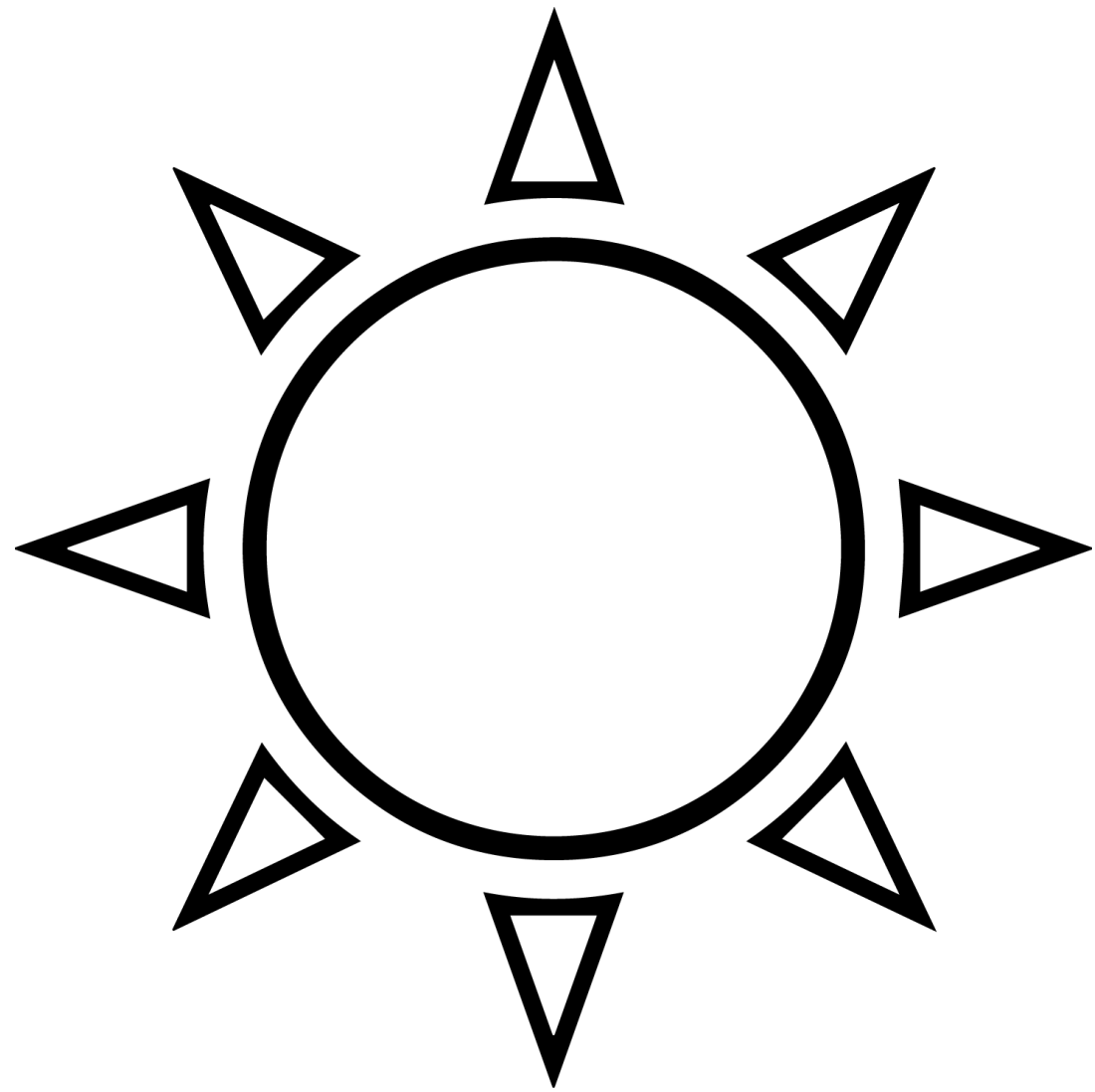

sun

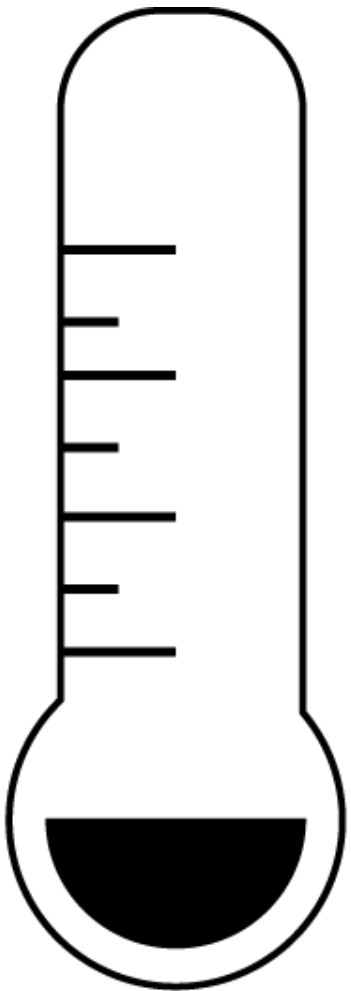

10° C

temperature

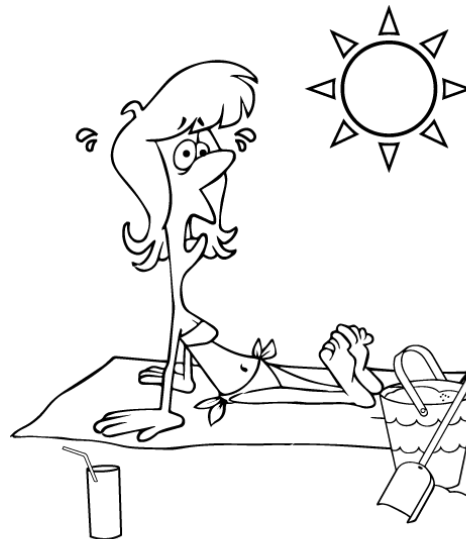
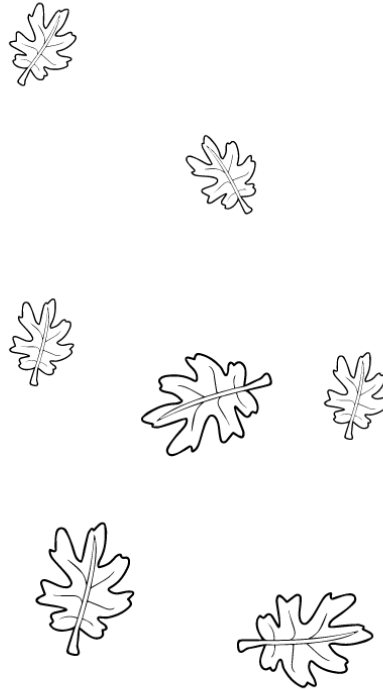

season



Winter

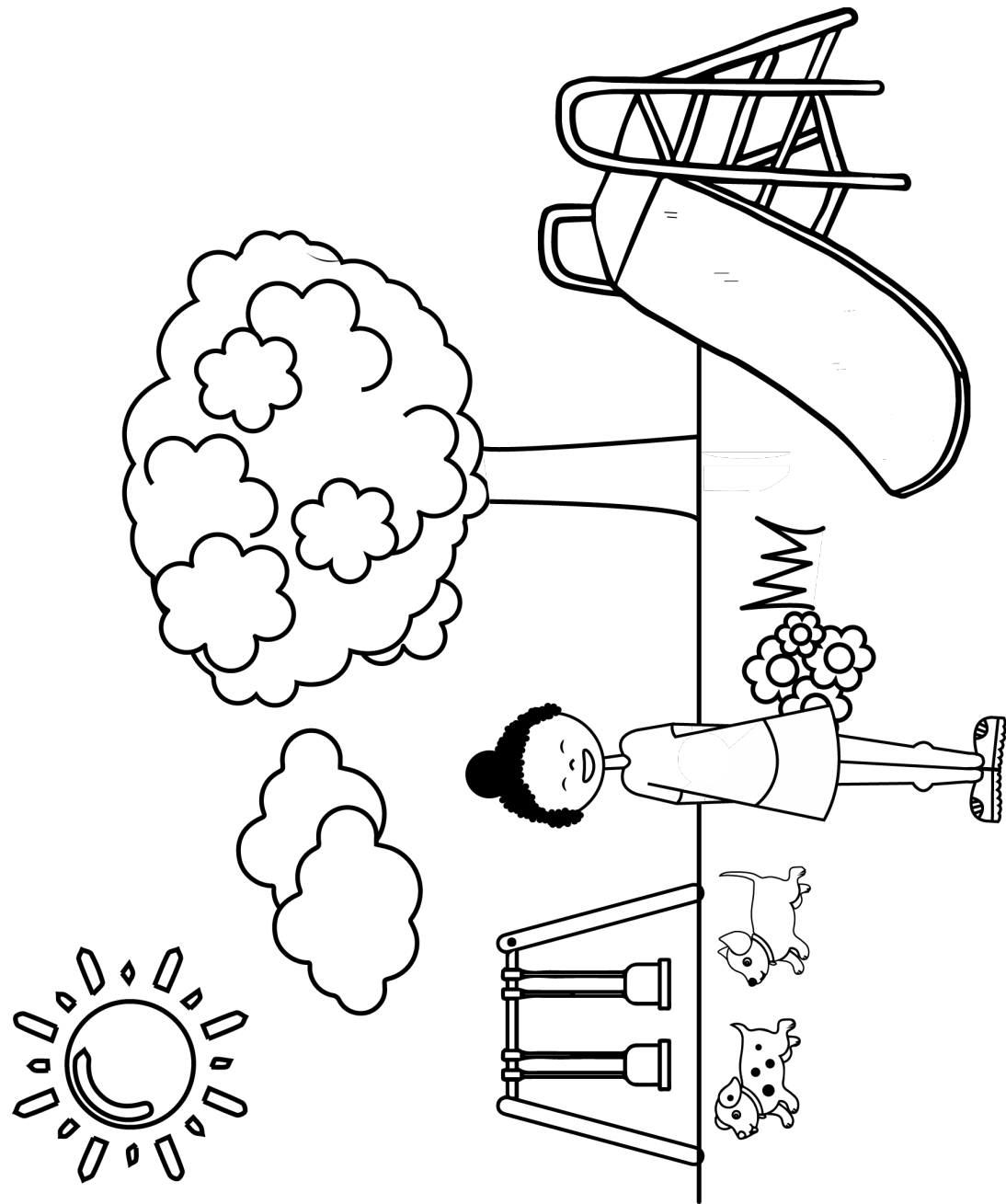

Summer

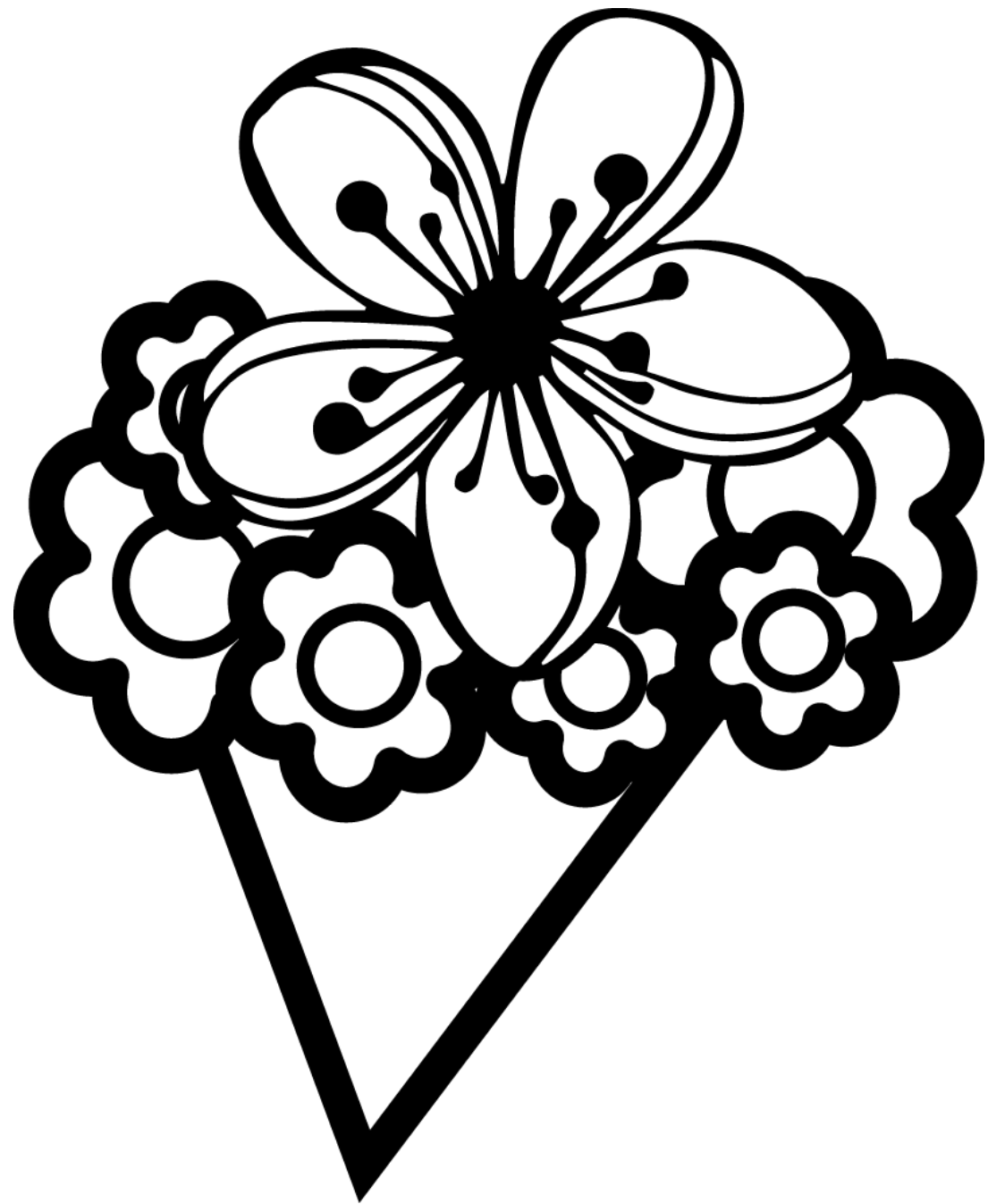

flowers

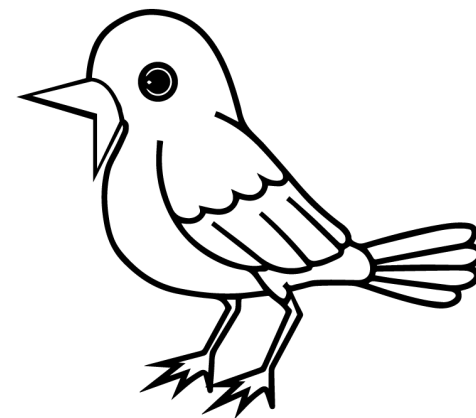
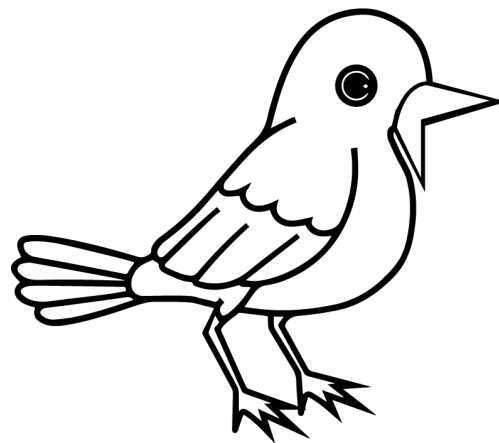

Spring

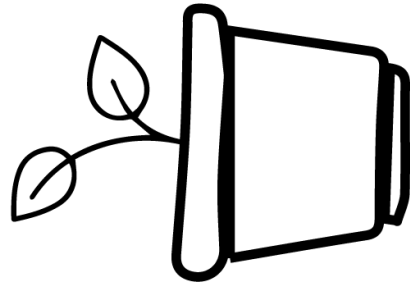
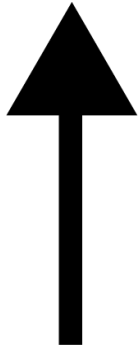
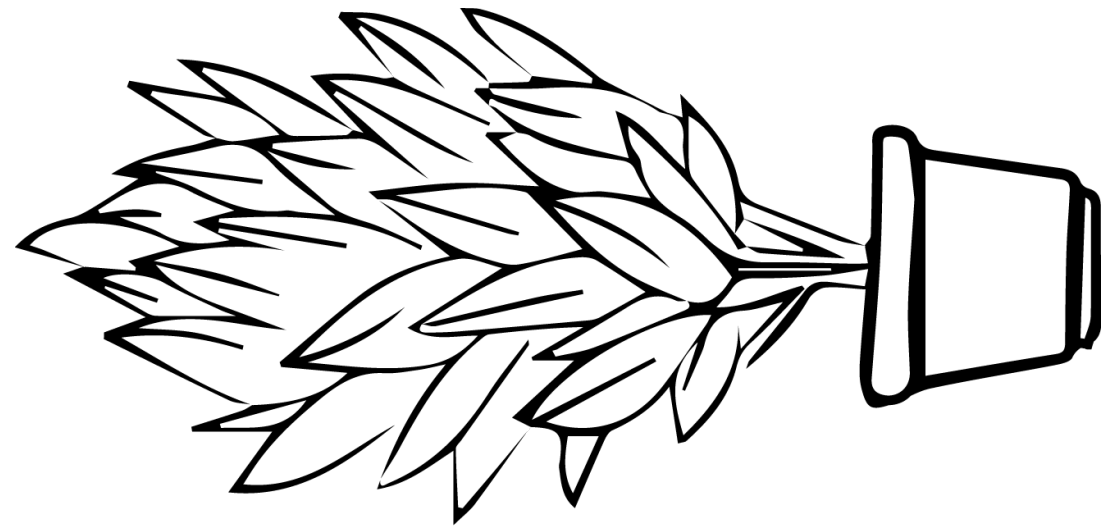

grow

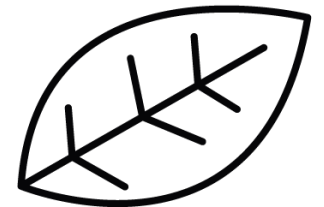
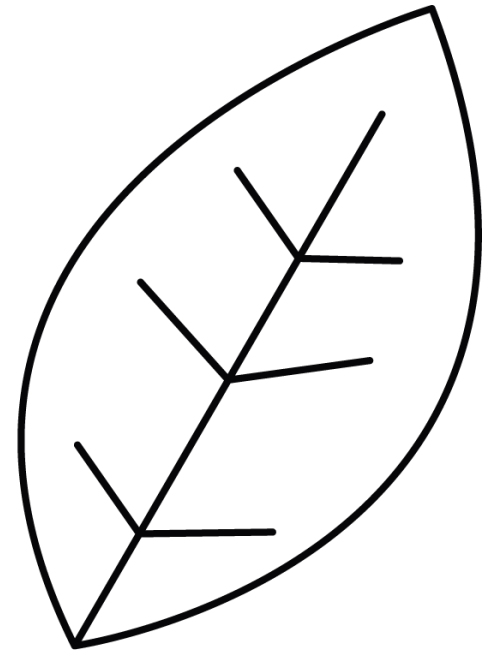
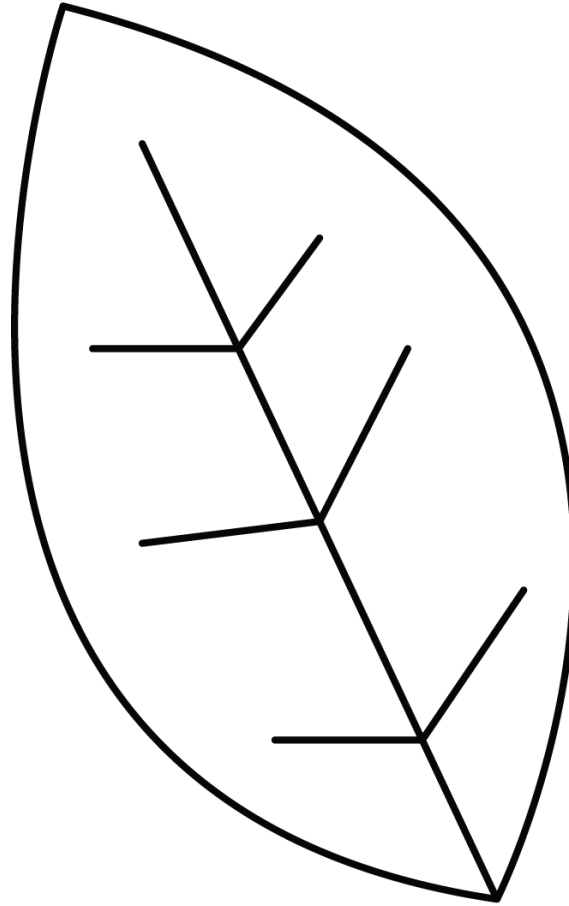

leaves

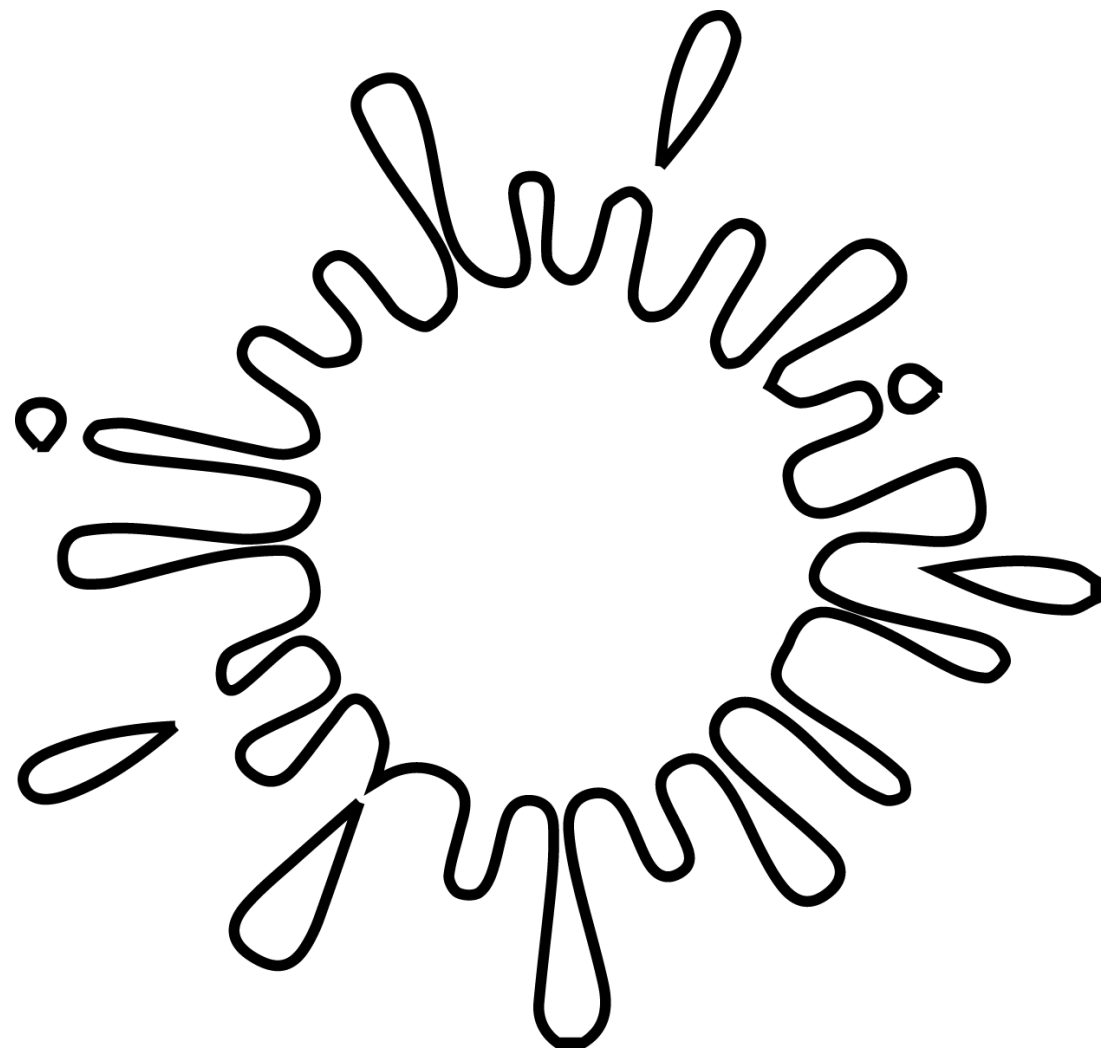

splash

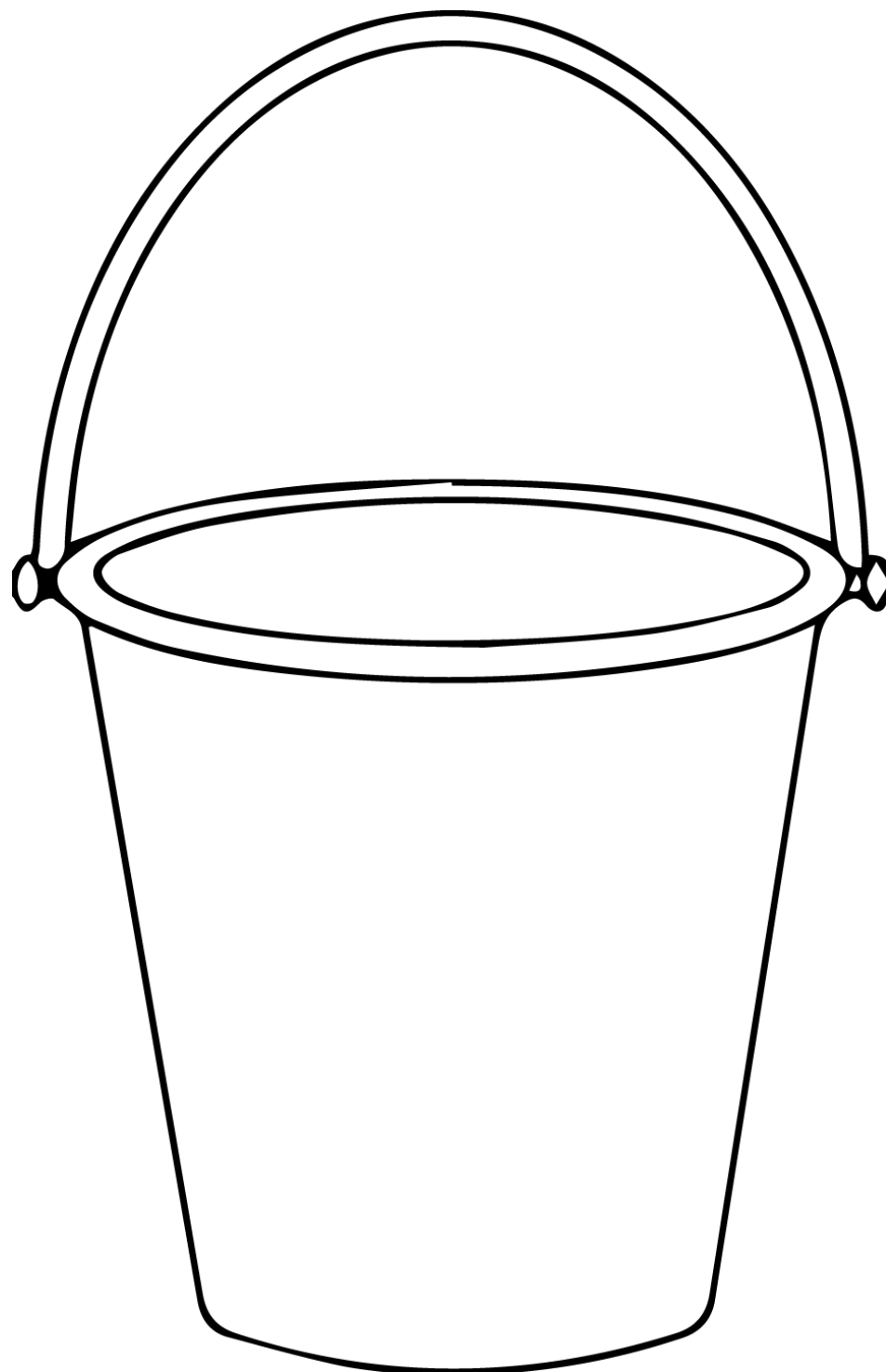

bucket

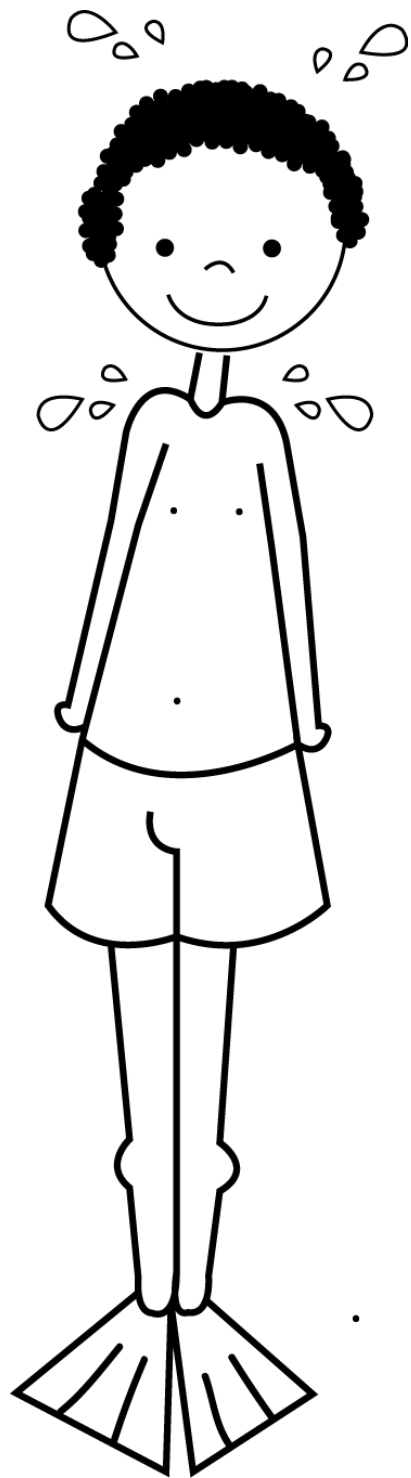

wet



dry

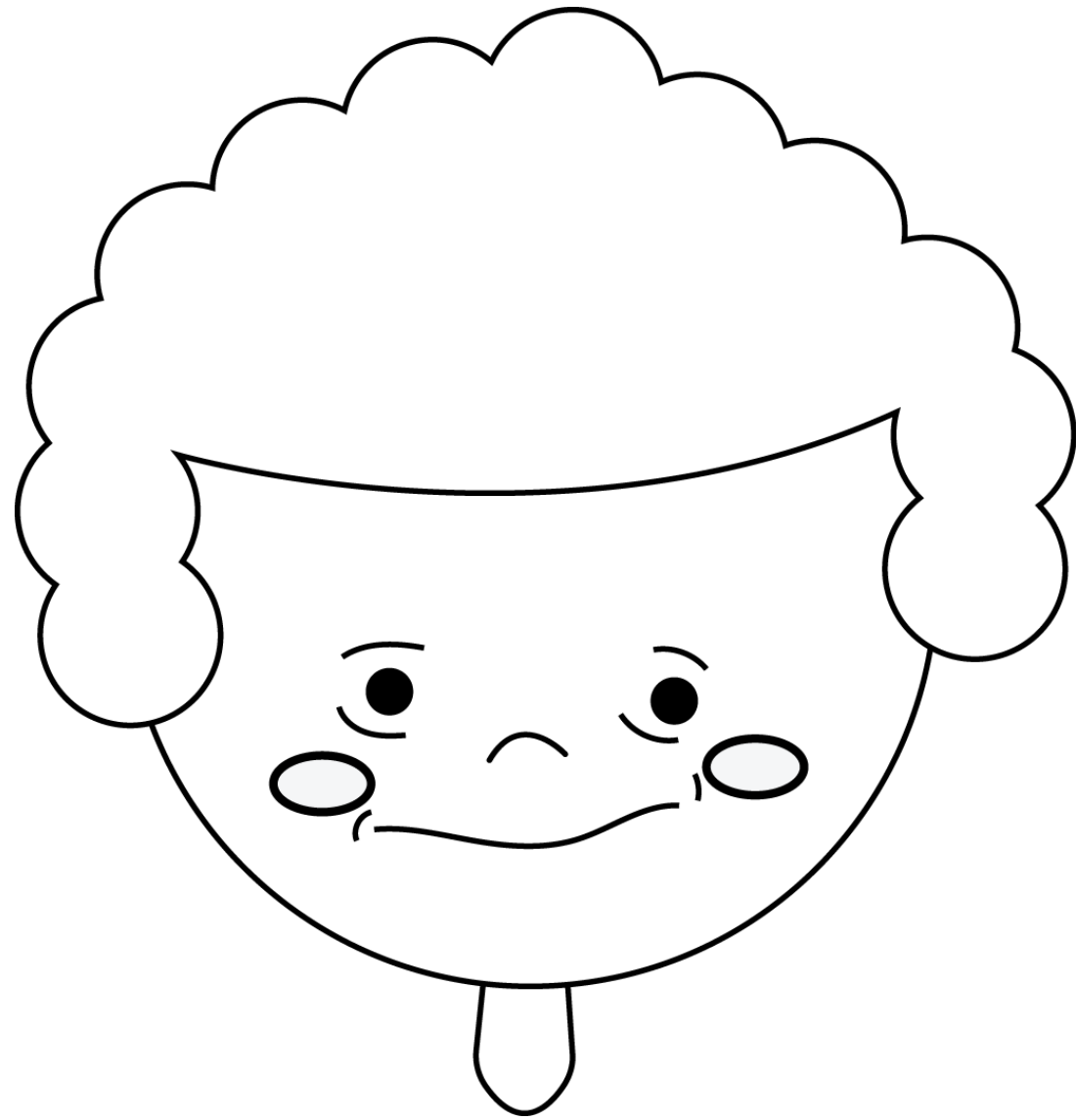

embarrassed

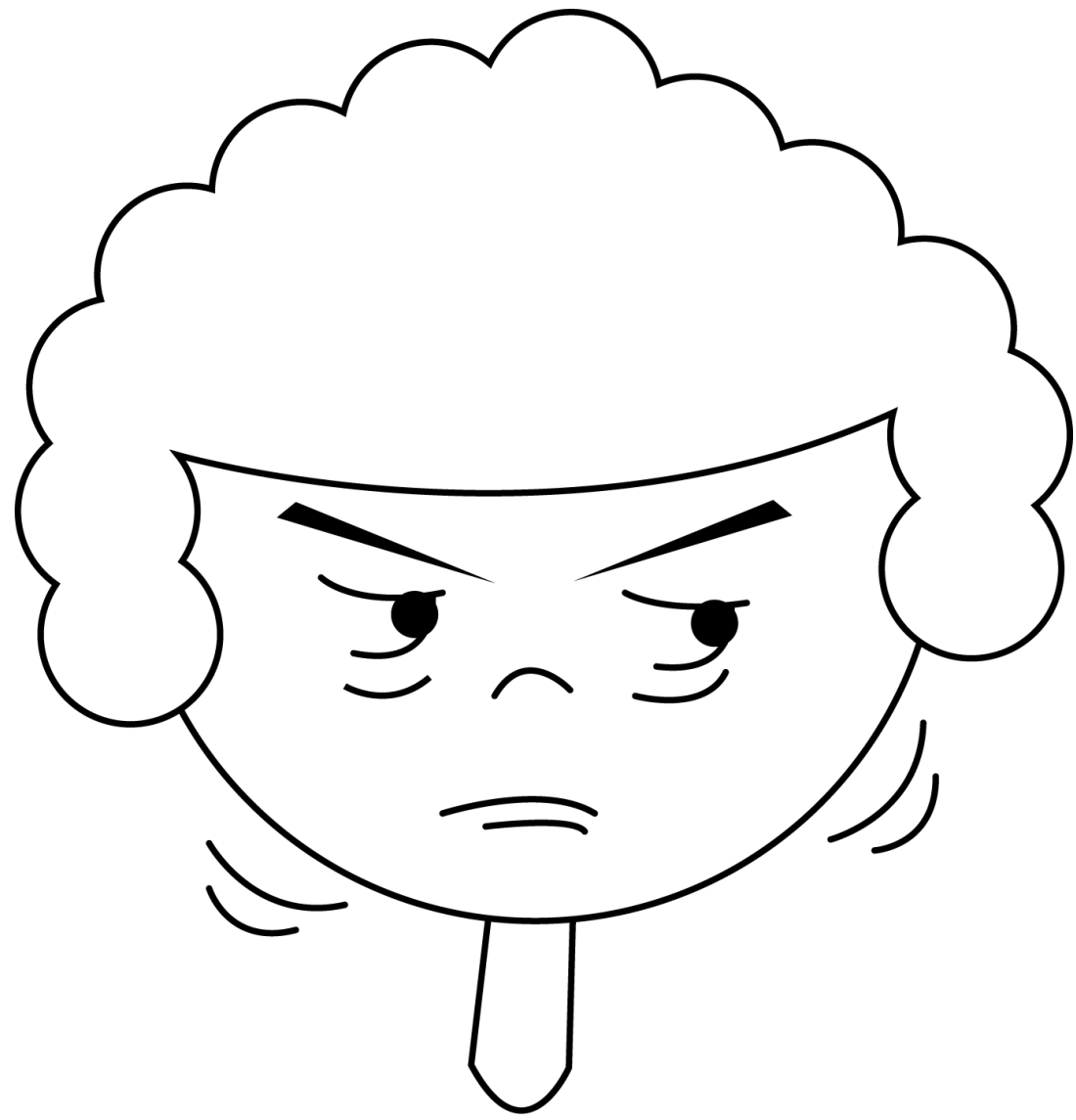

mad

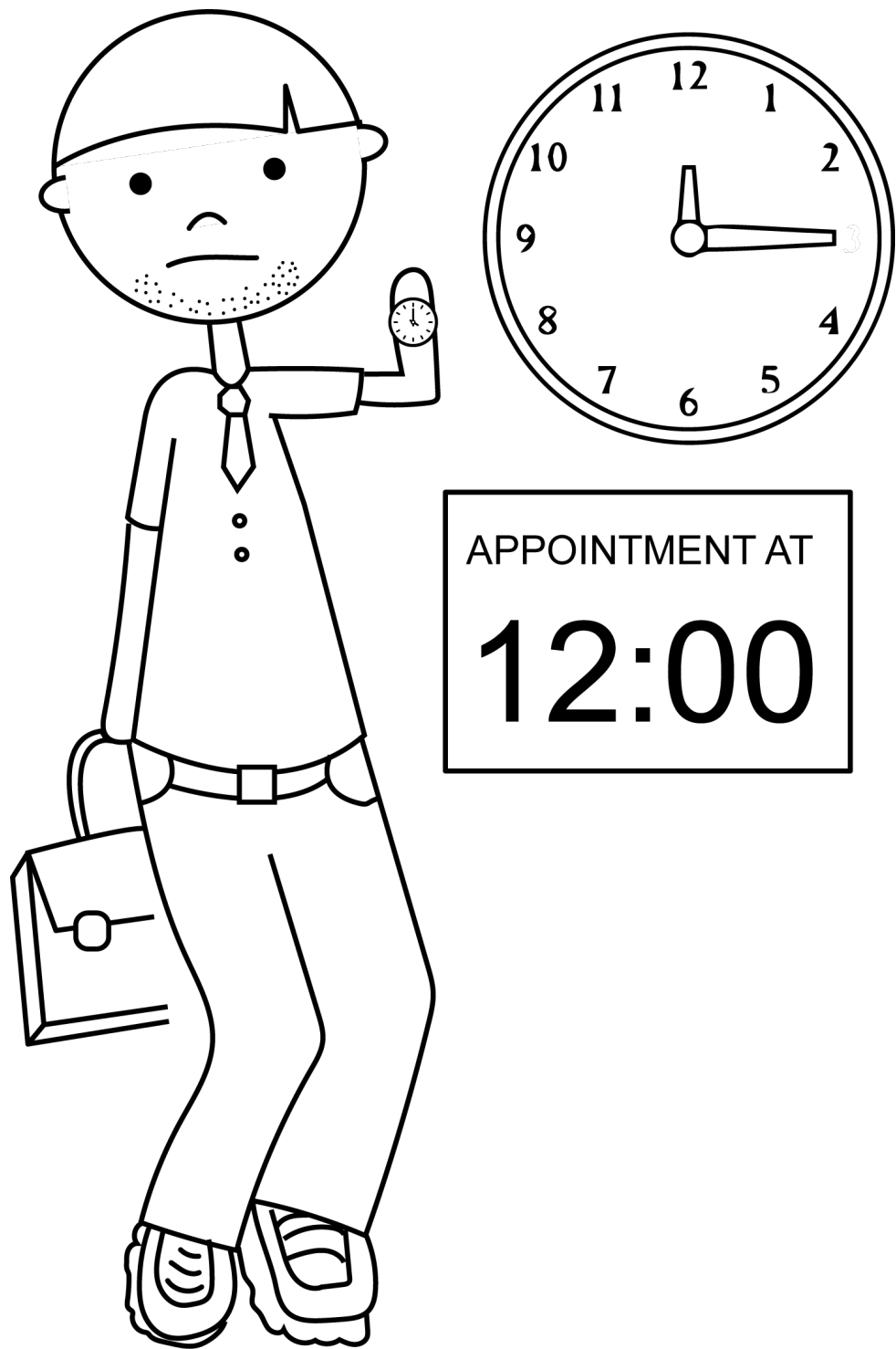

late

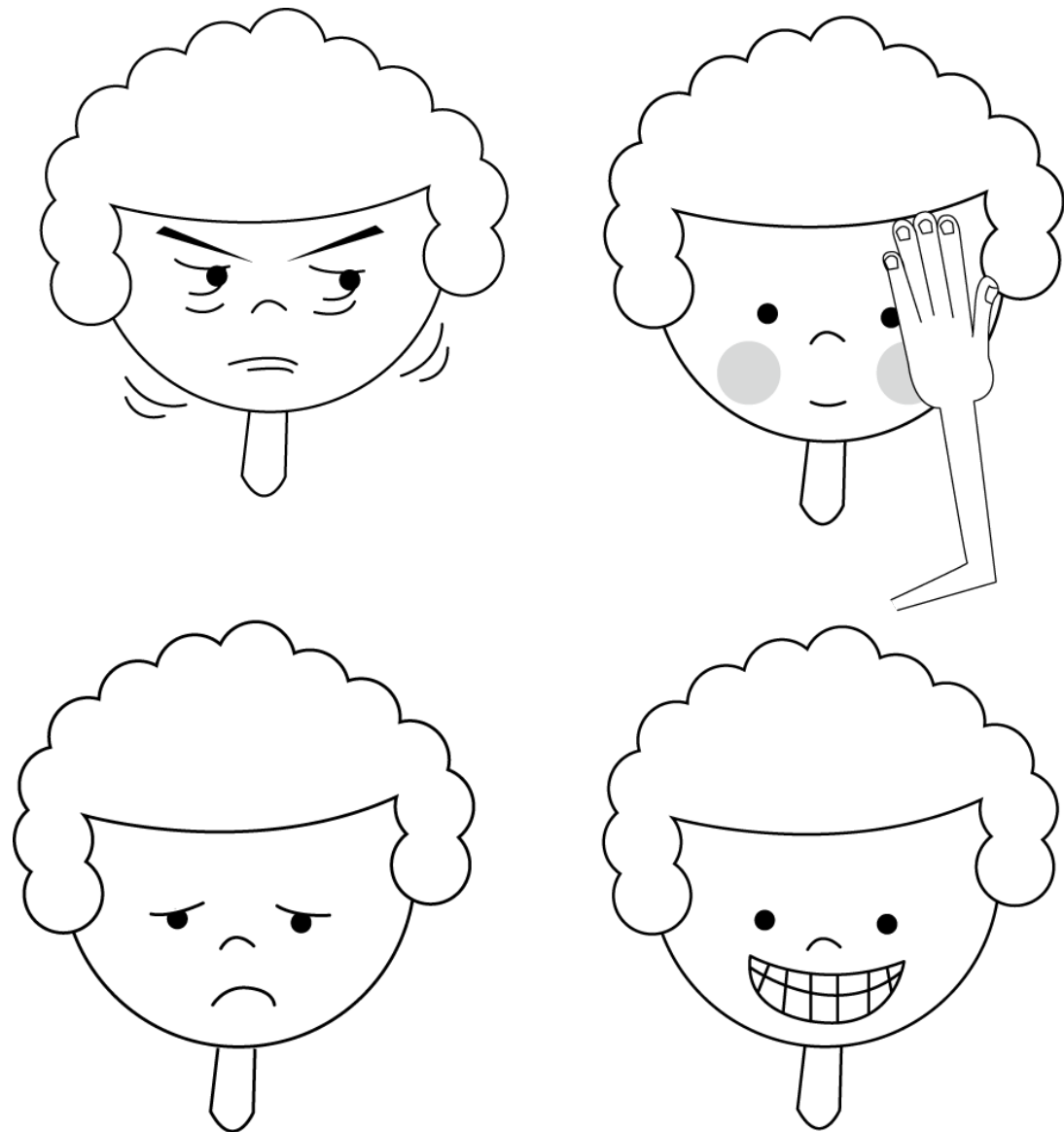

feeling

shmeh!

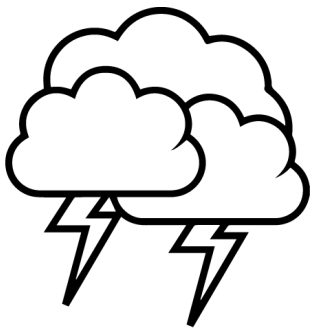

no

grumpy

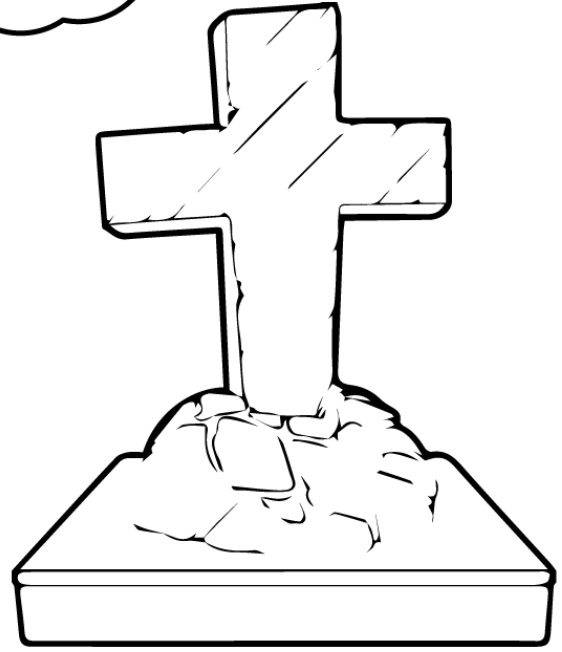
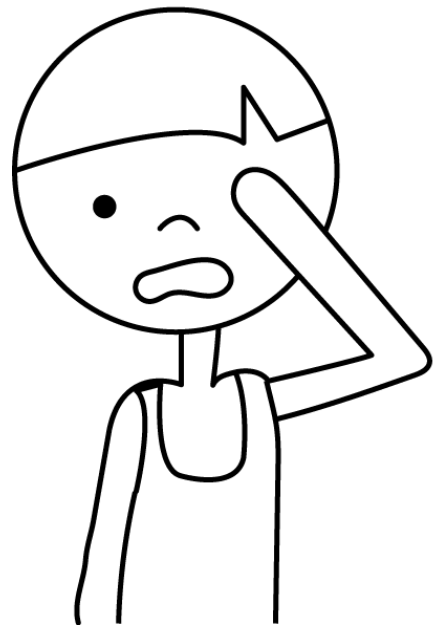

miss

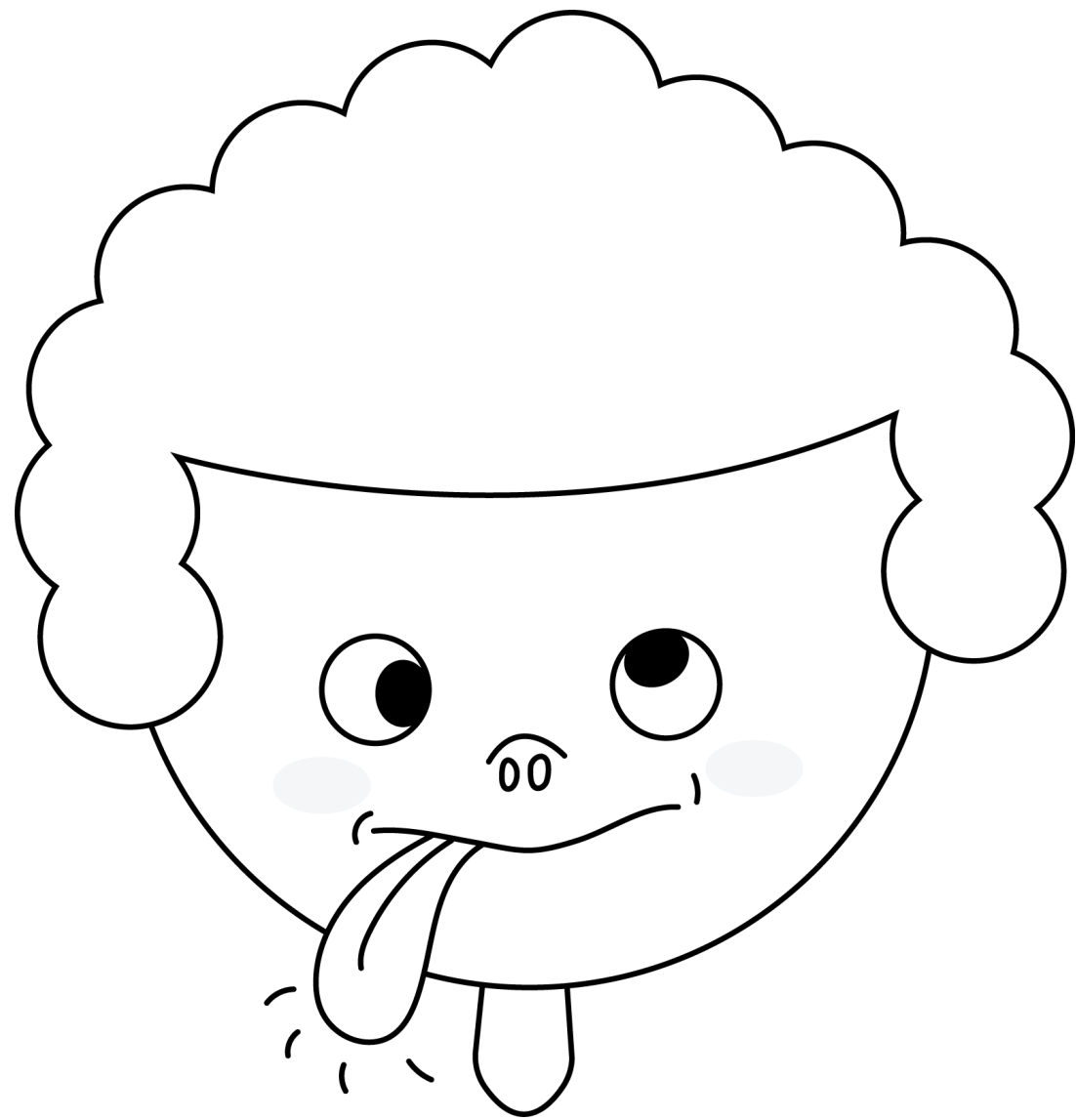

silly

relaxed

Happy

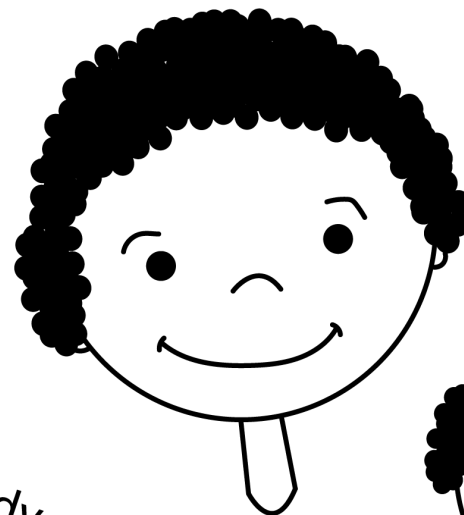

moody

sad



bored

angry

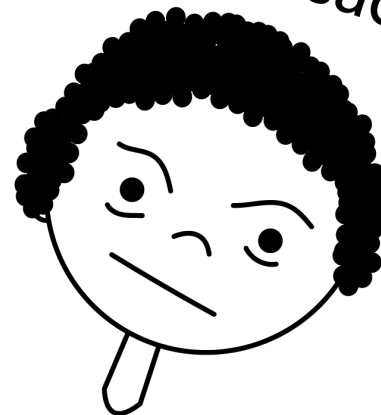

mood

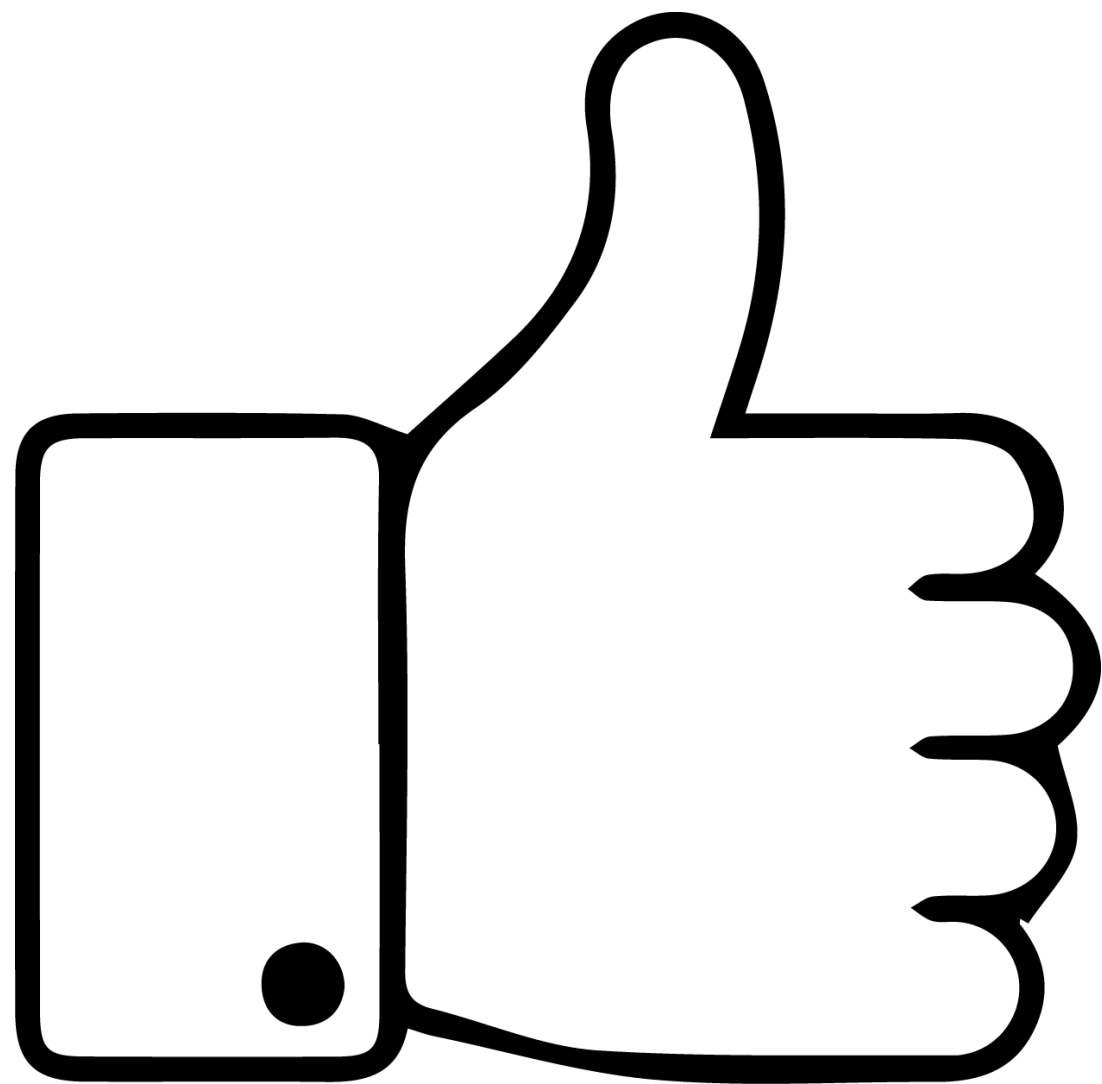

good

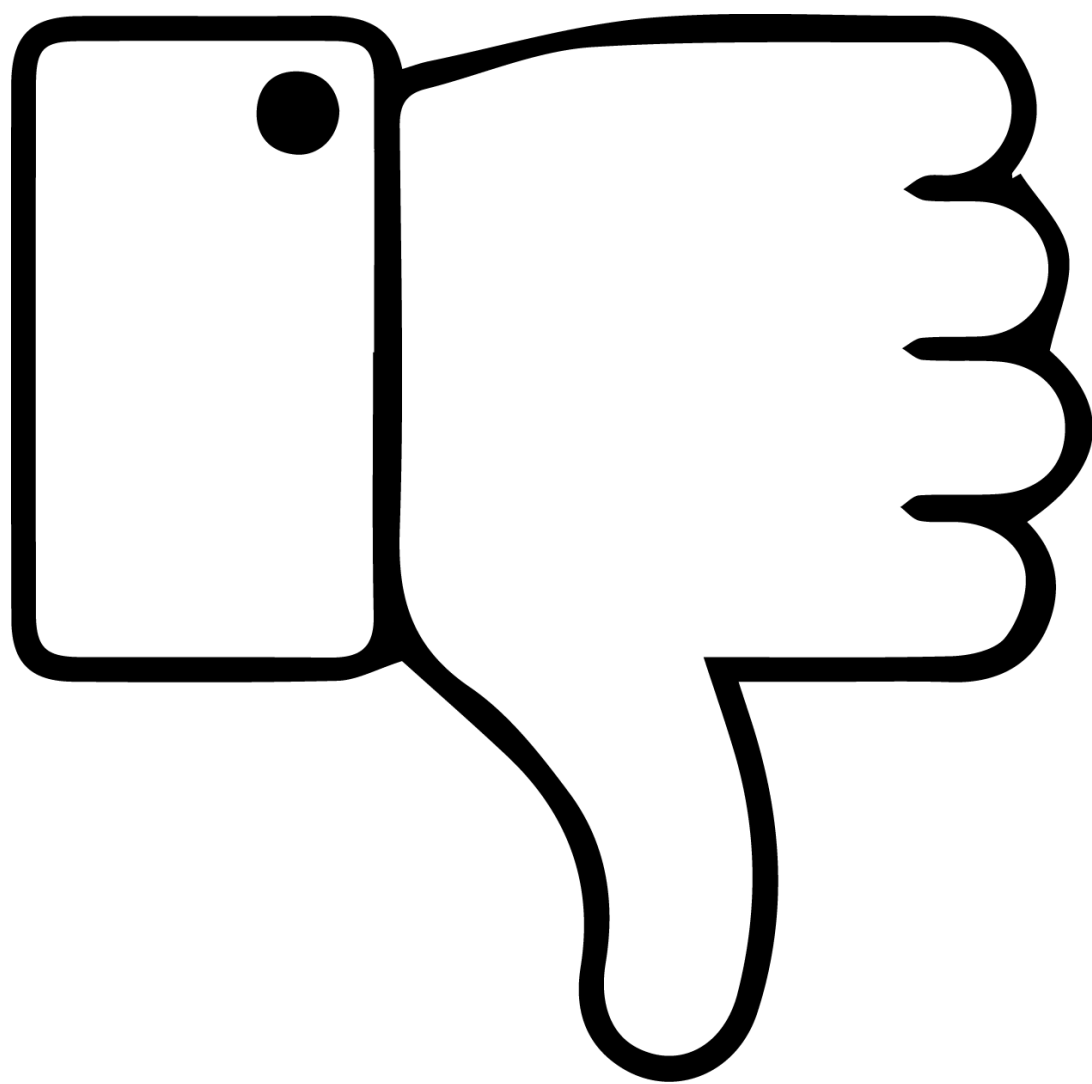

bad

FINAL EXAM

- _____ x
- _____ x
- _____ x
- _____ x
- _____ x
- _____ x
- _____ x
- _____ x
- _____ x
- _____ x

wrong



wear

FINAL EXAM

- ✓
- ✓
- ✓
- ✗
- ✓
- ✓
- ✓
- ✓
- ✓
- ✓

mistake

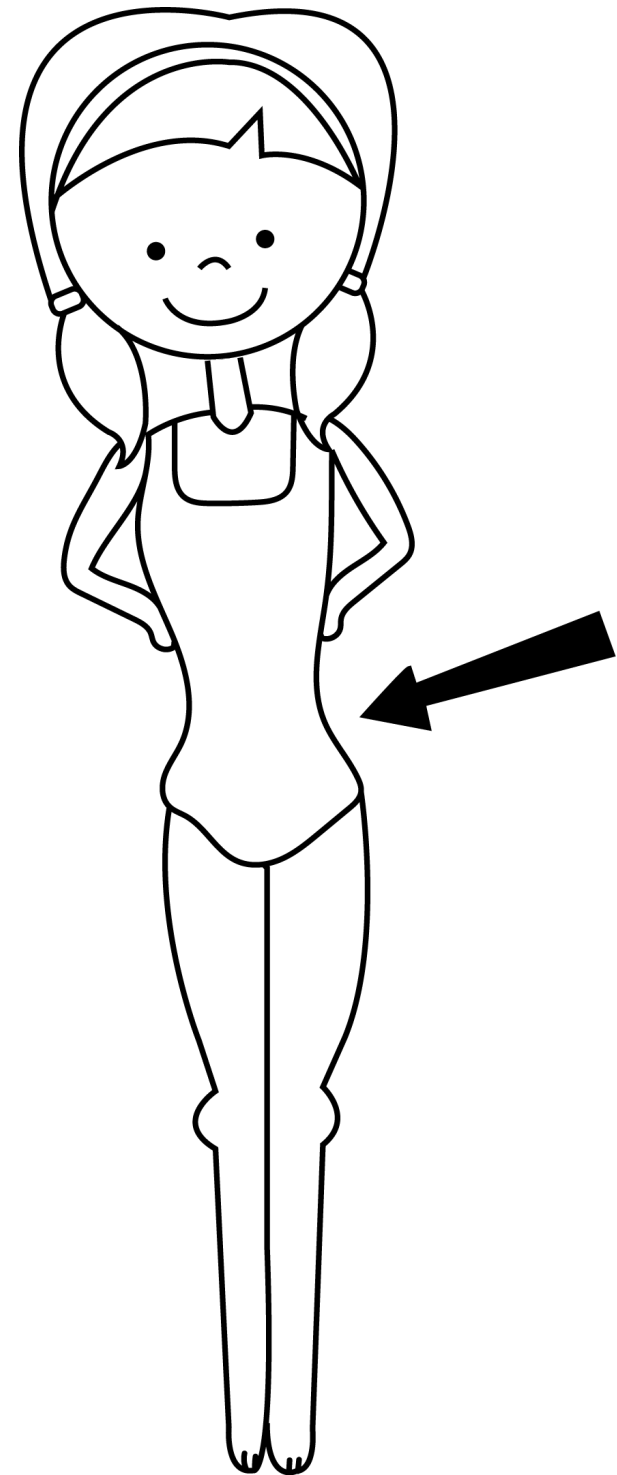

swimming costume



calm

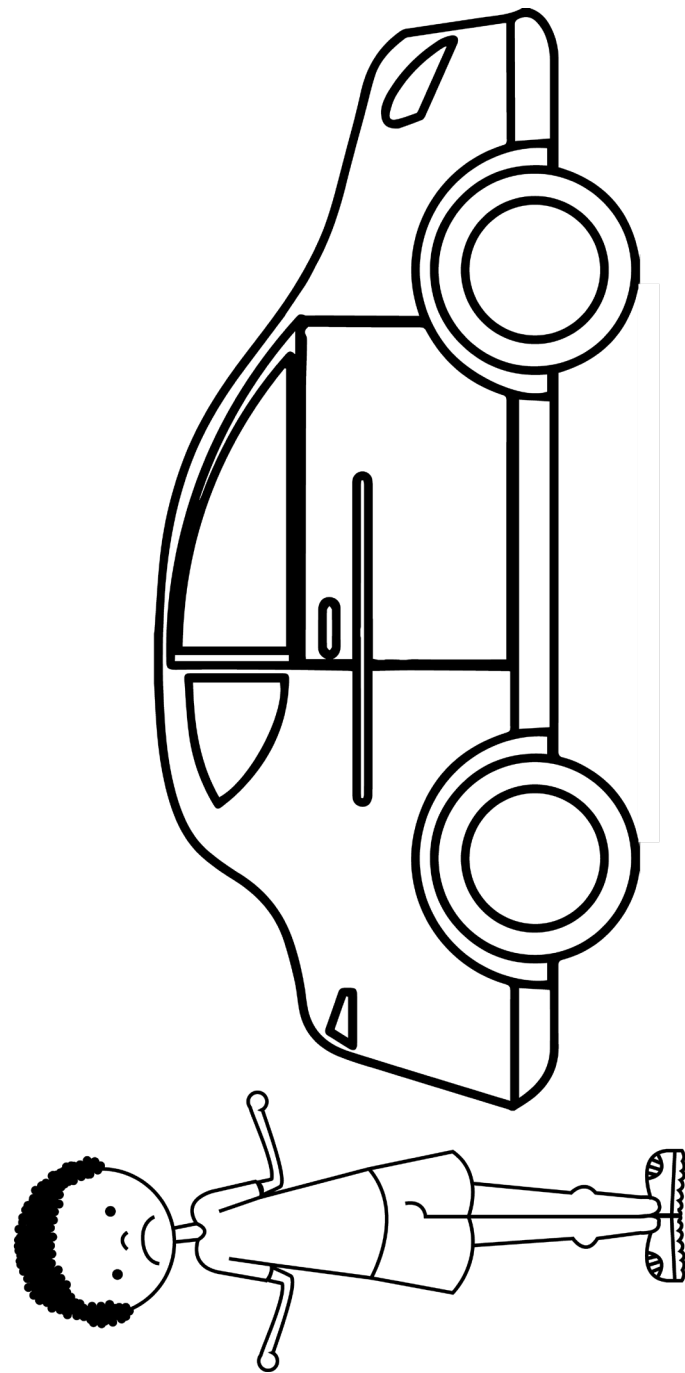
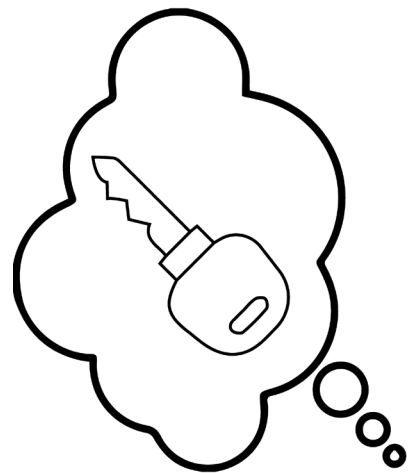

forget

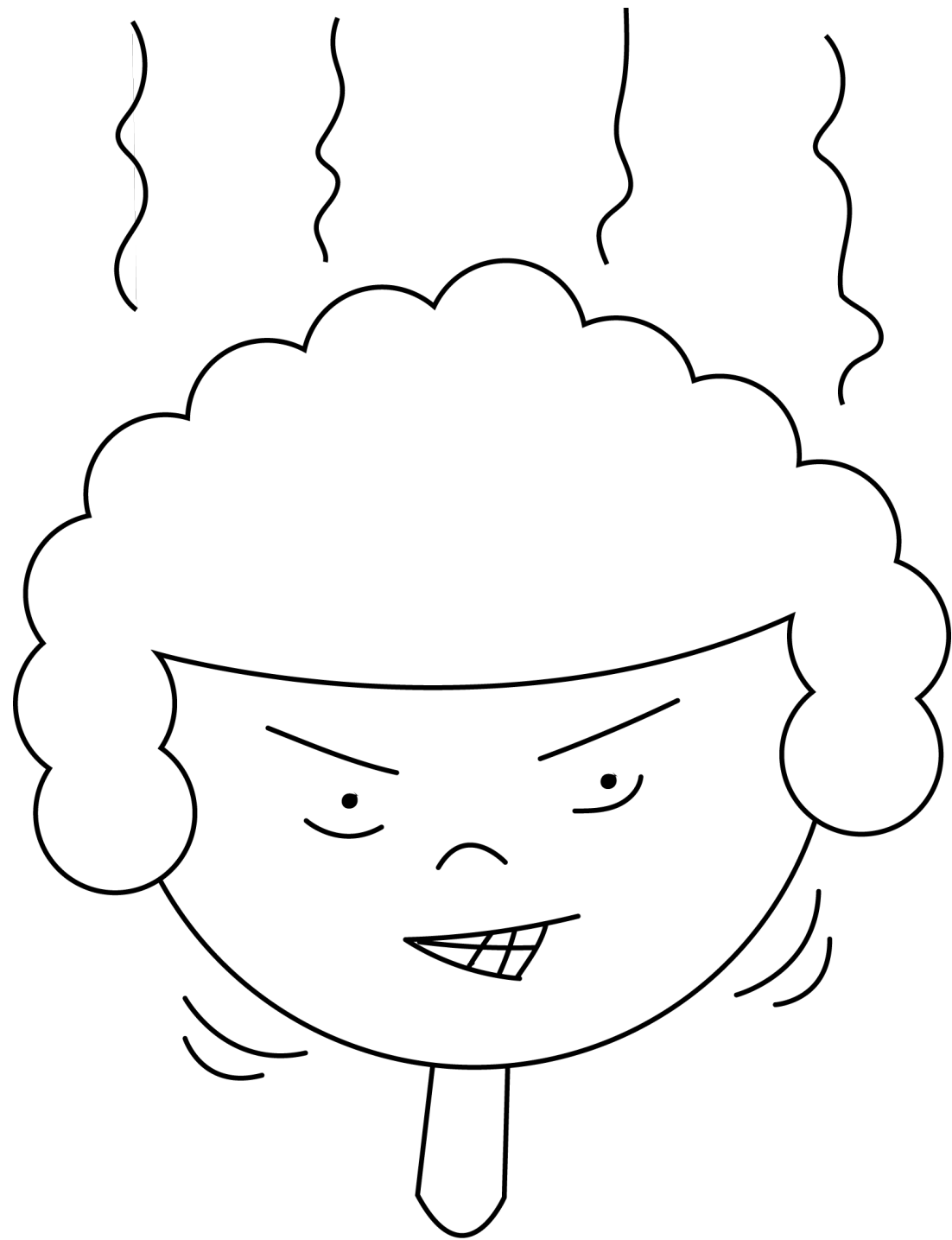

hate

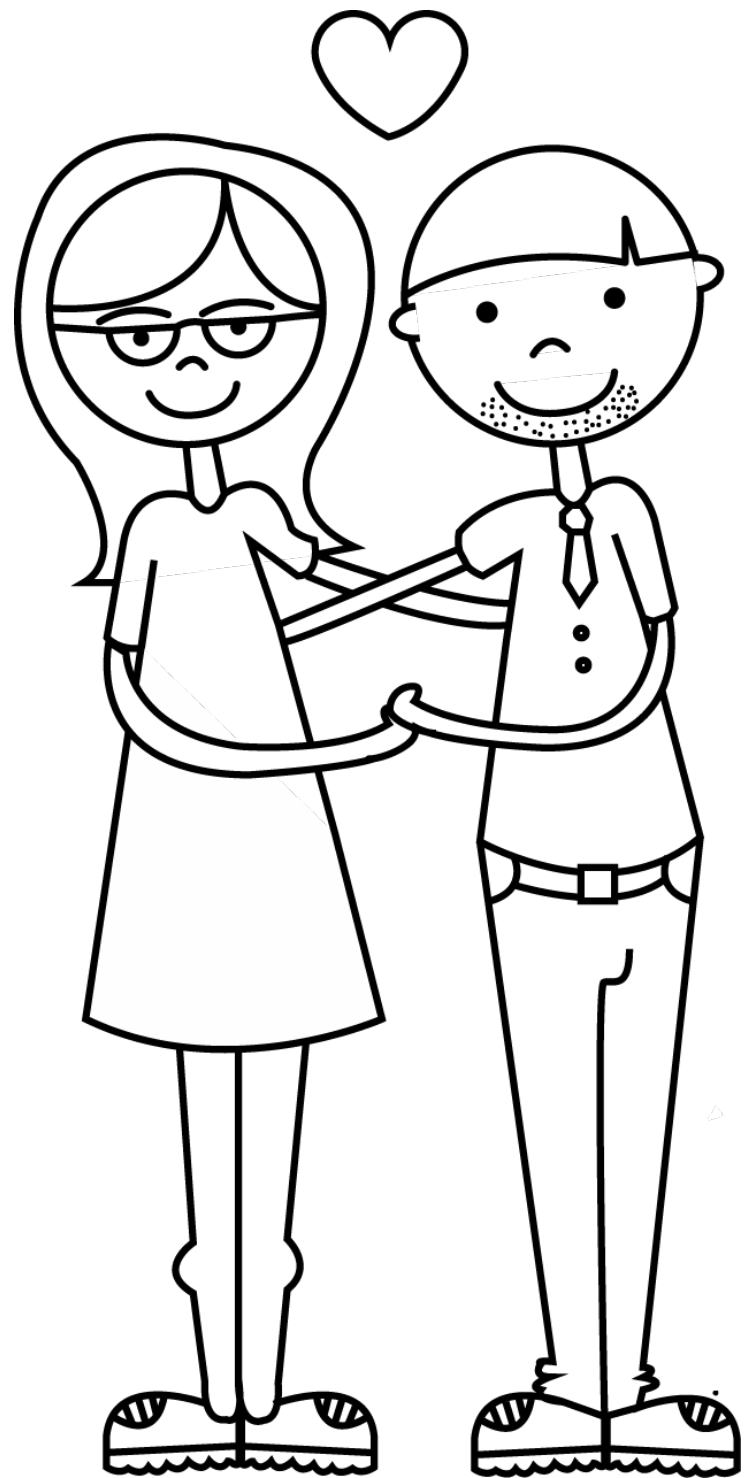

love

BZZZ

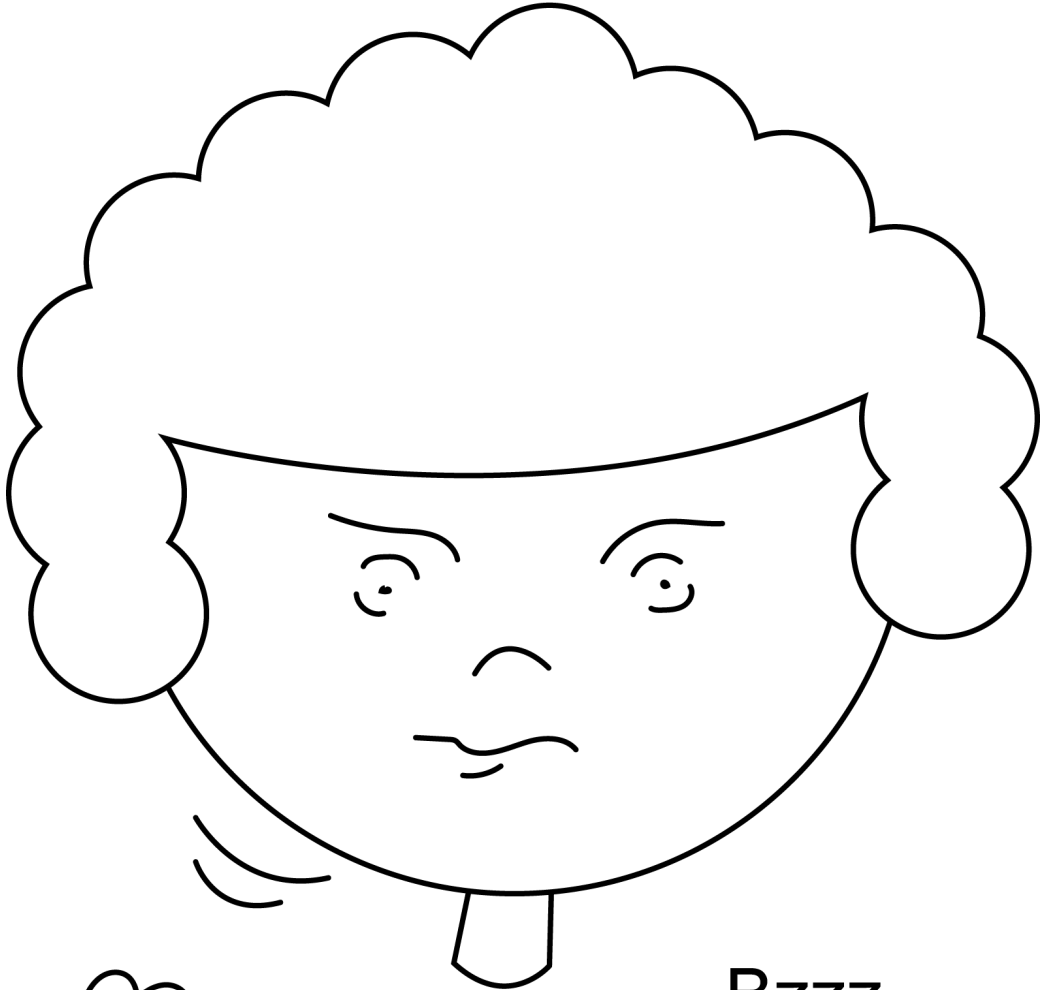
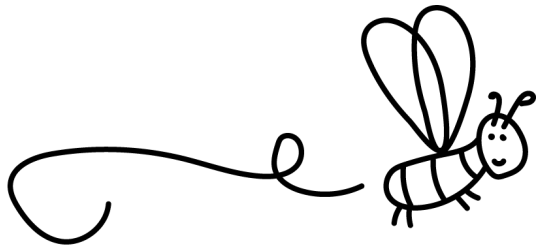

Bzzz

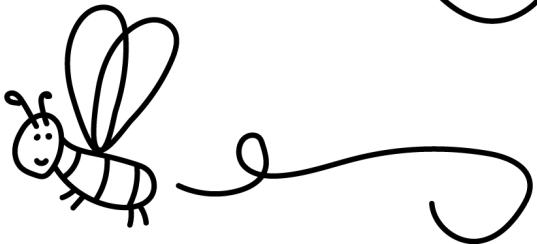

annoyed

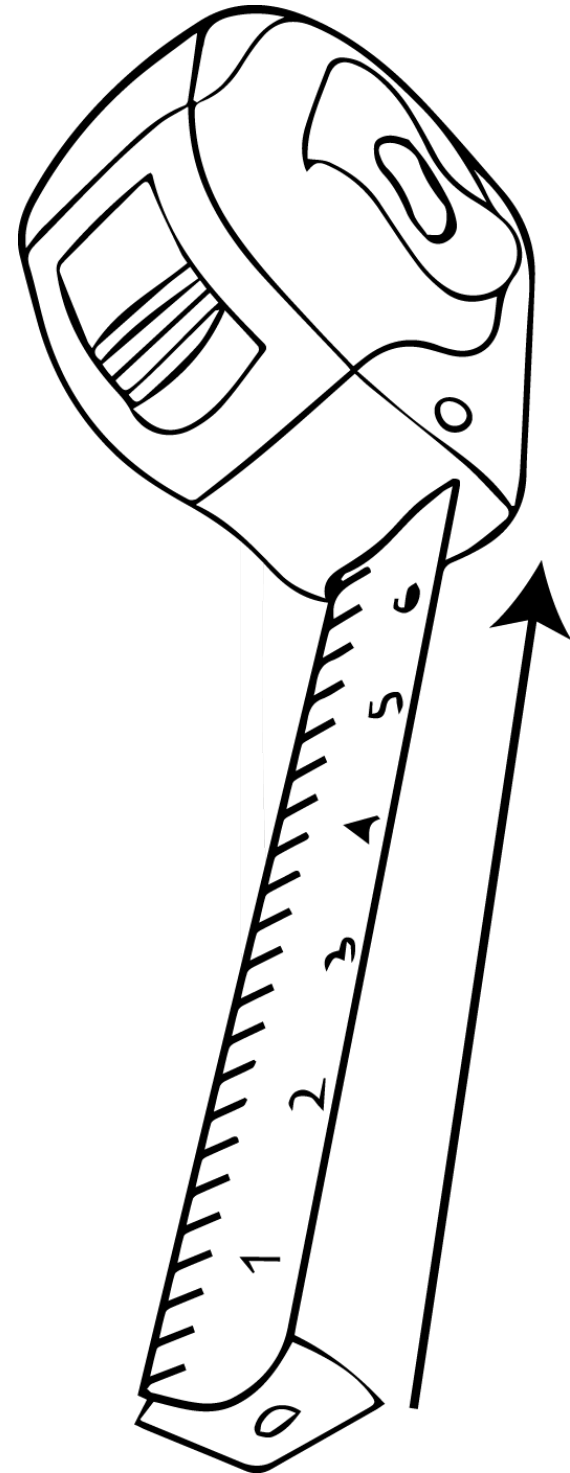

shorten

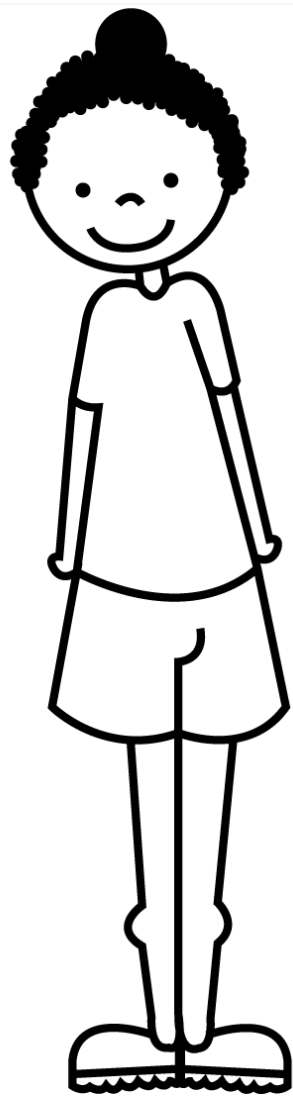

short

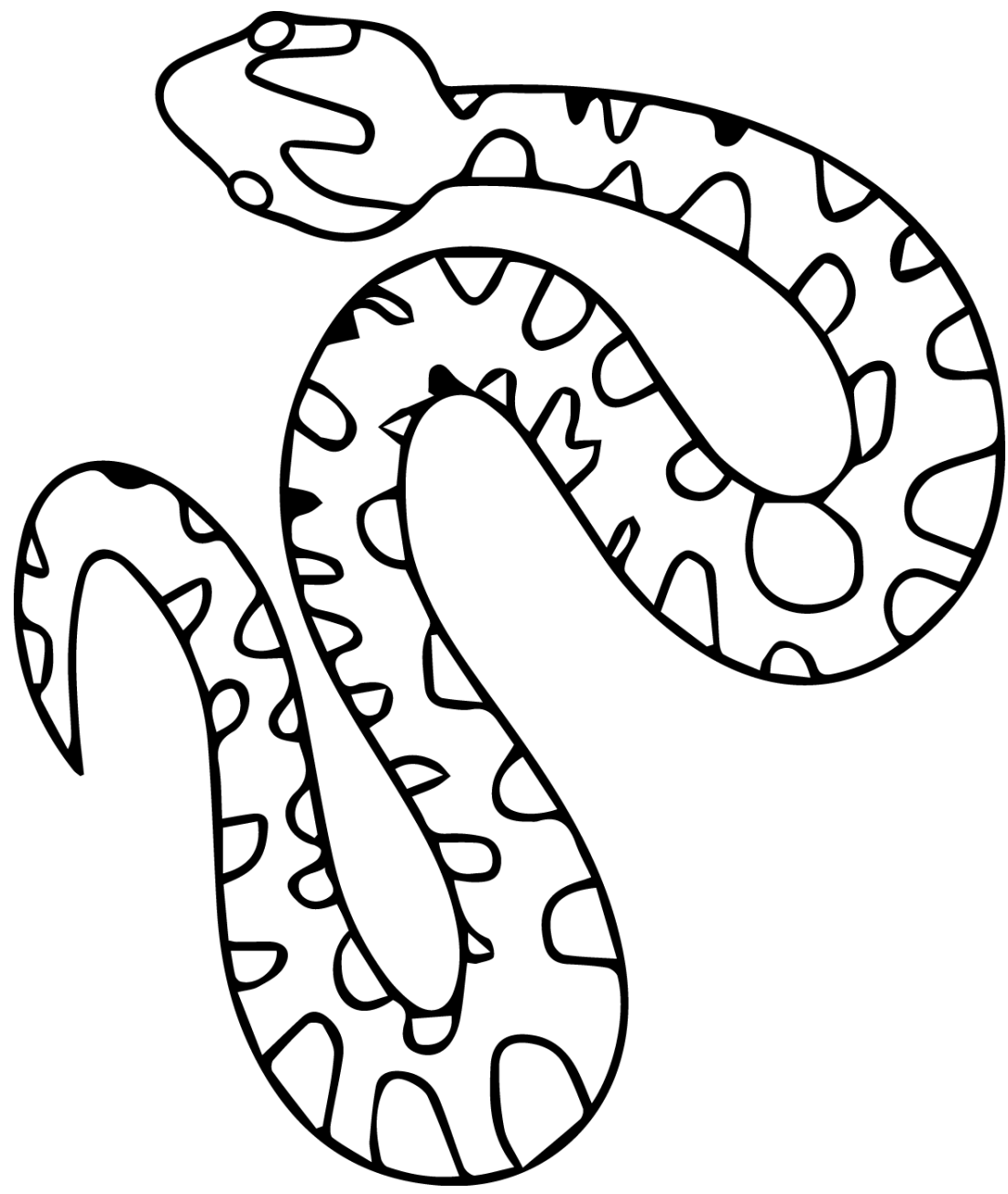
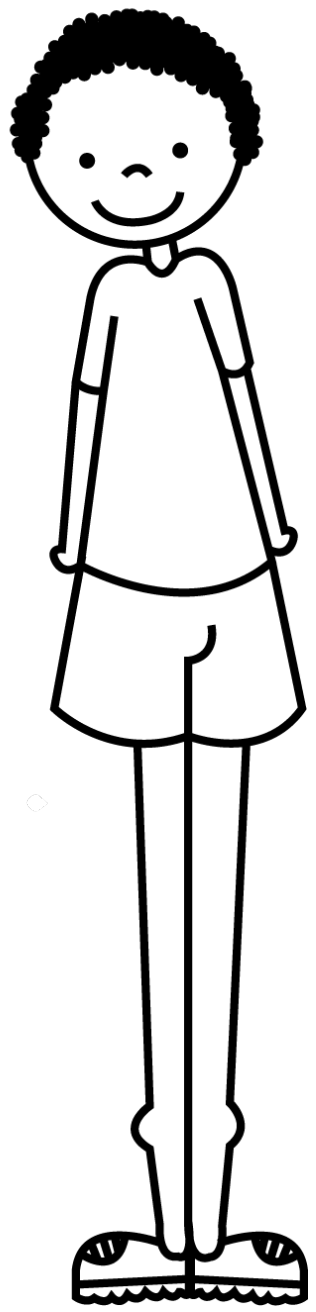

long

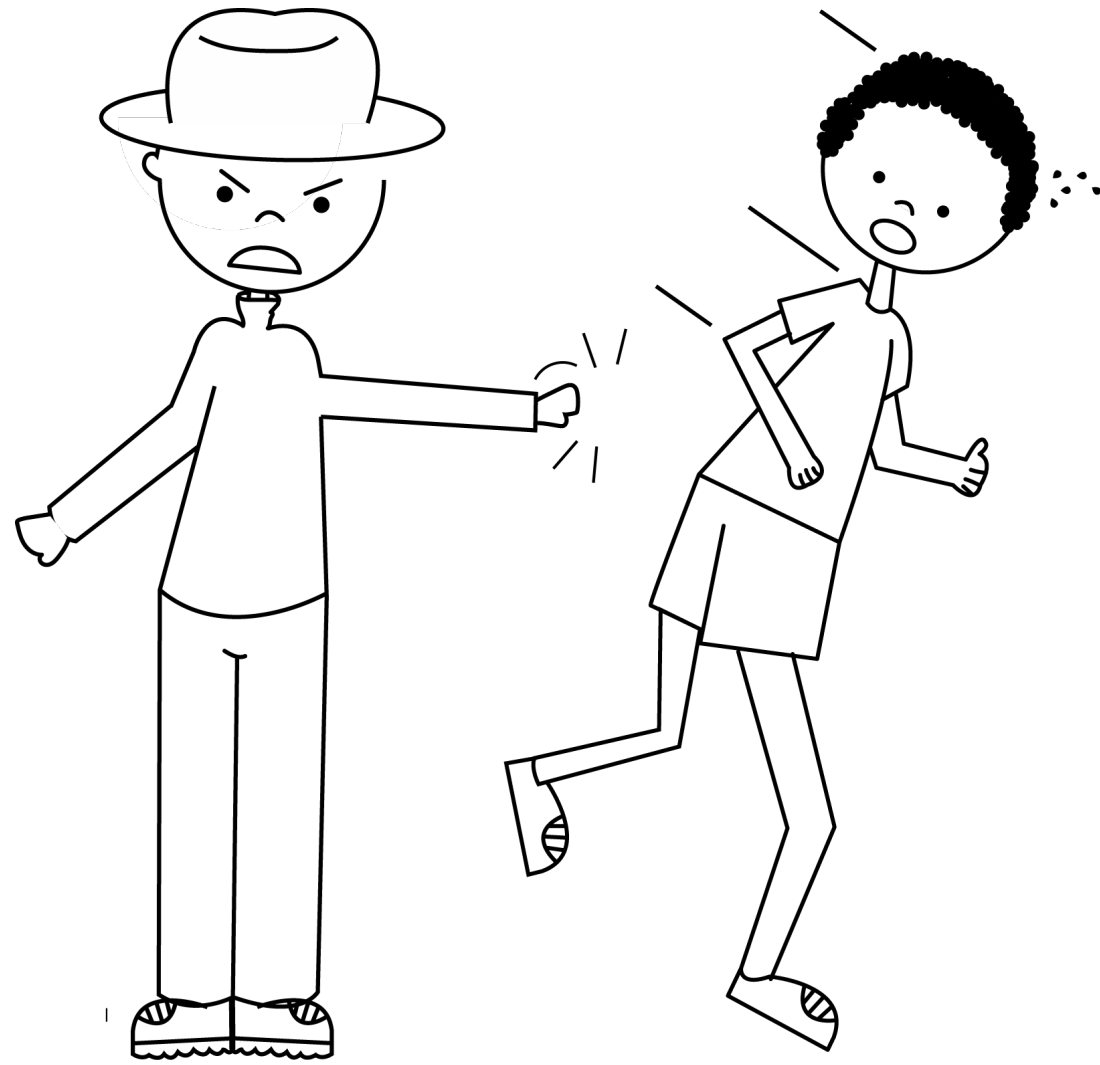

rude

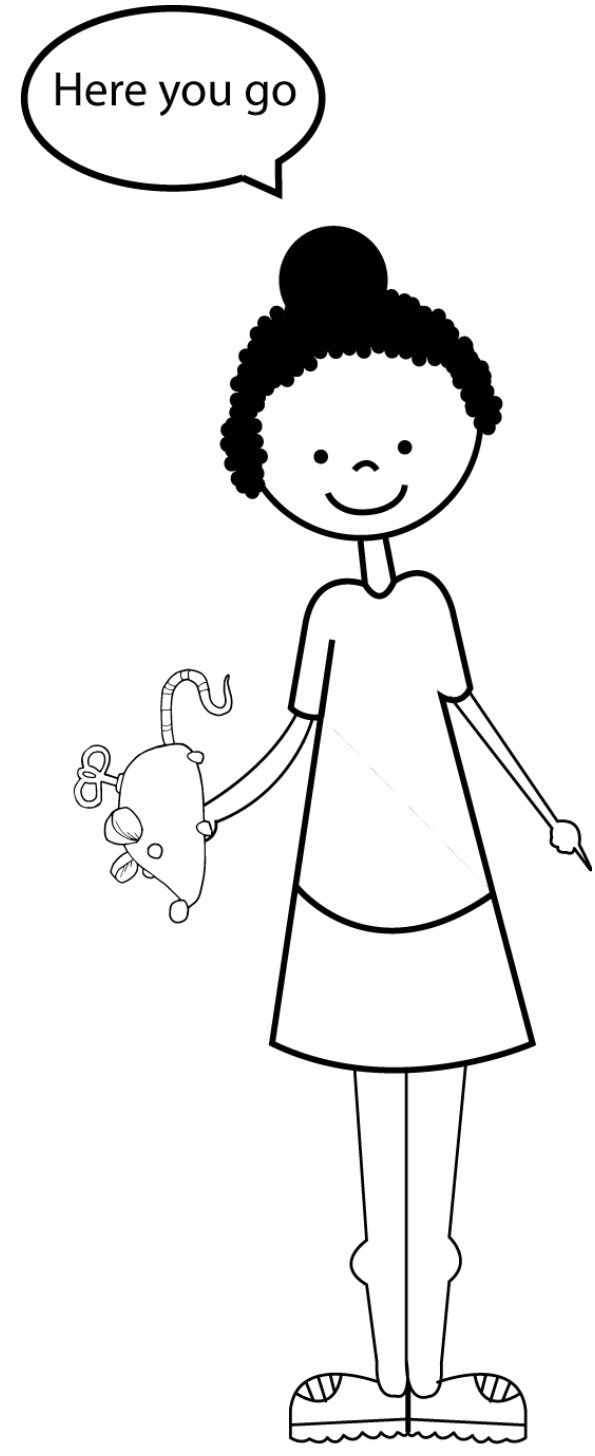
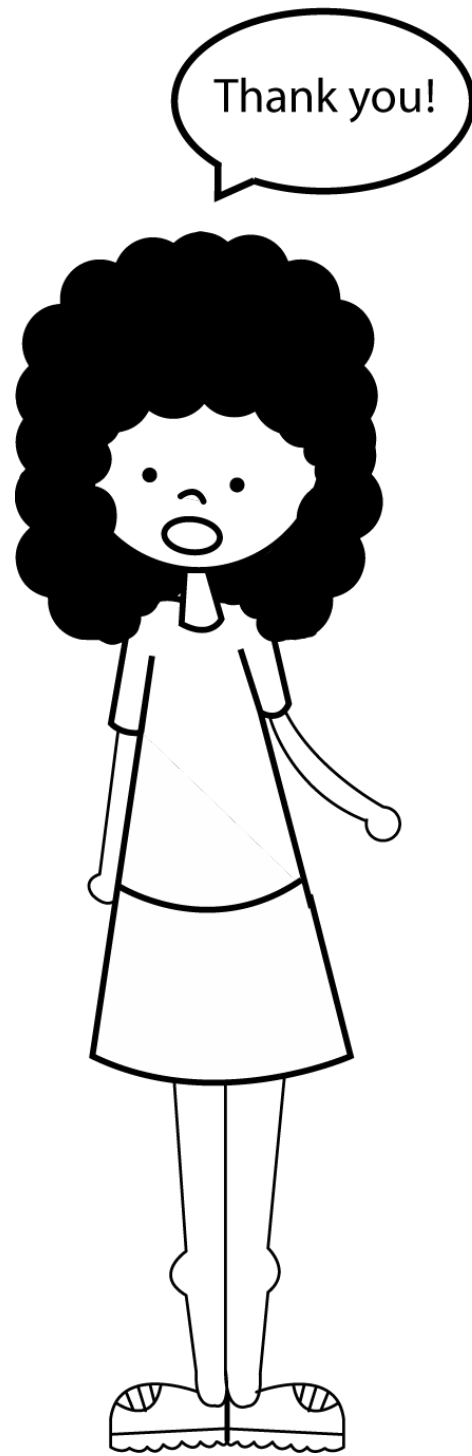

polite

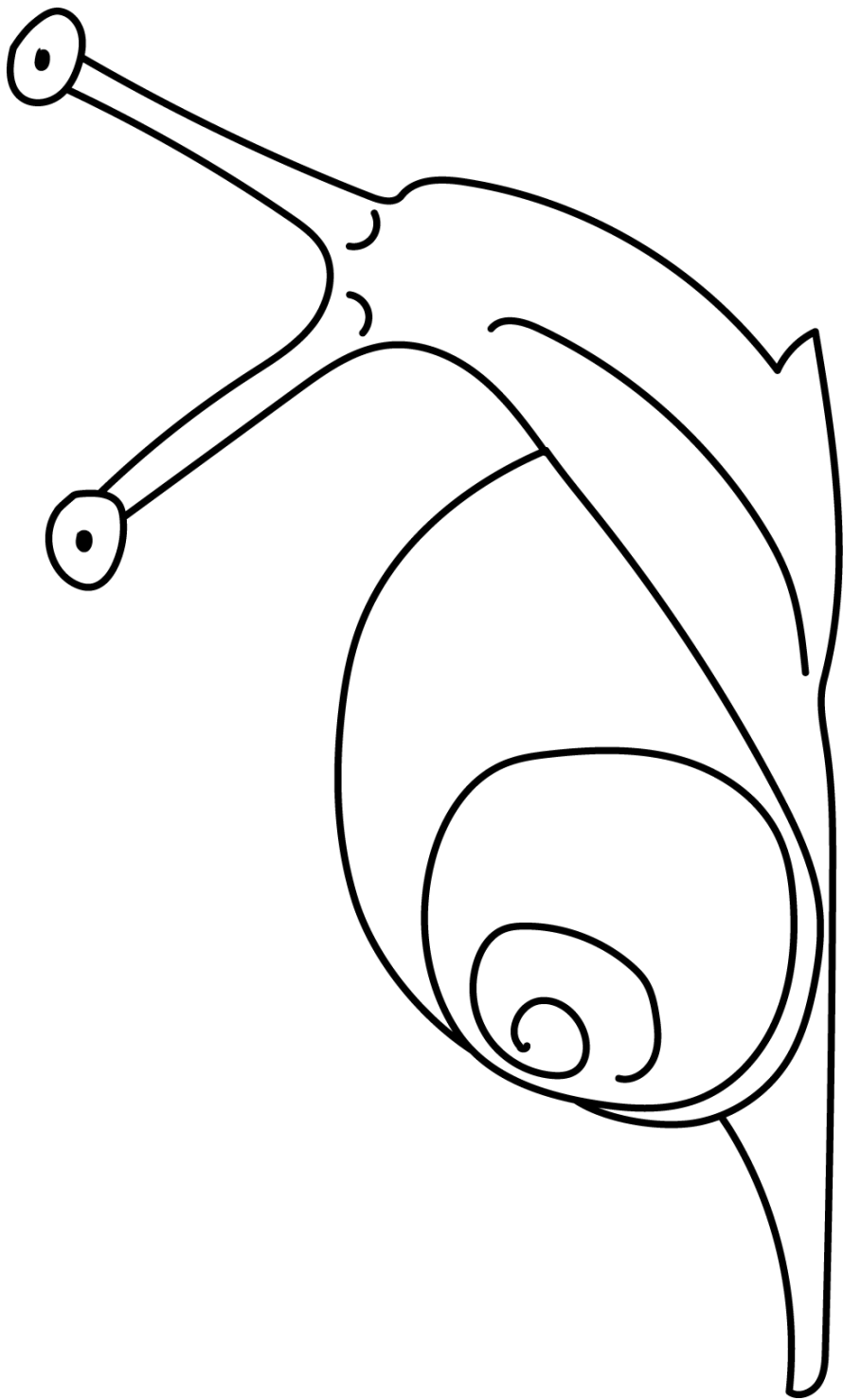

slowly

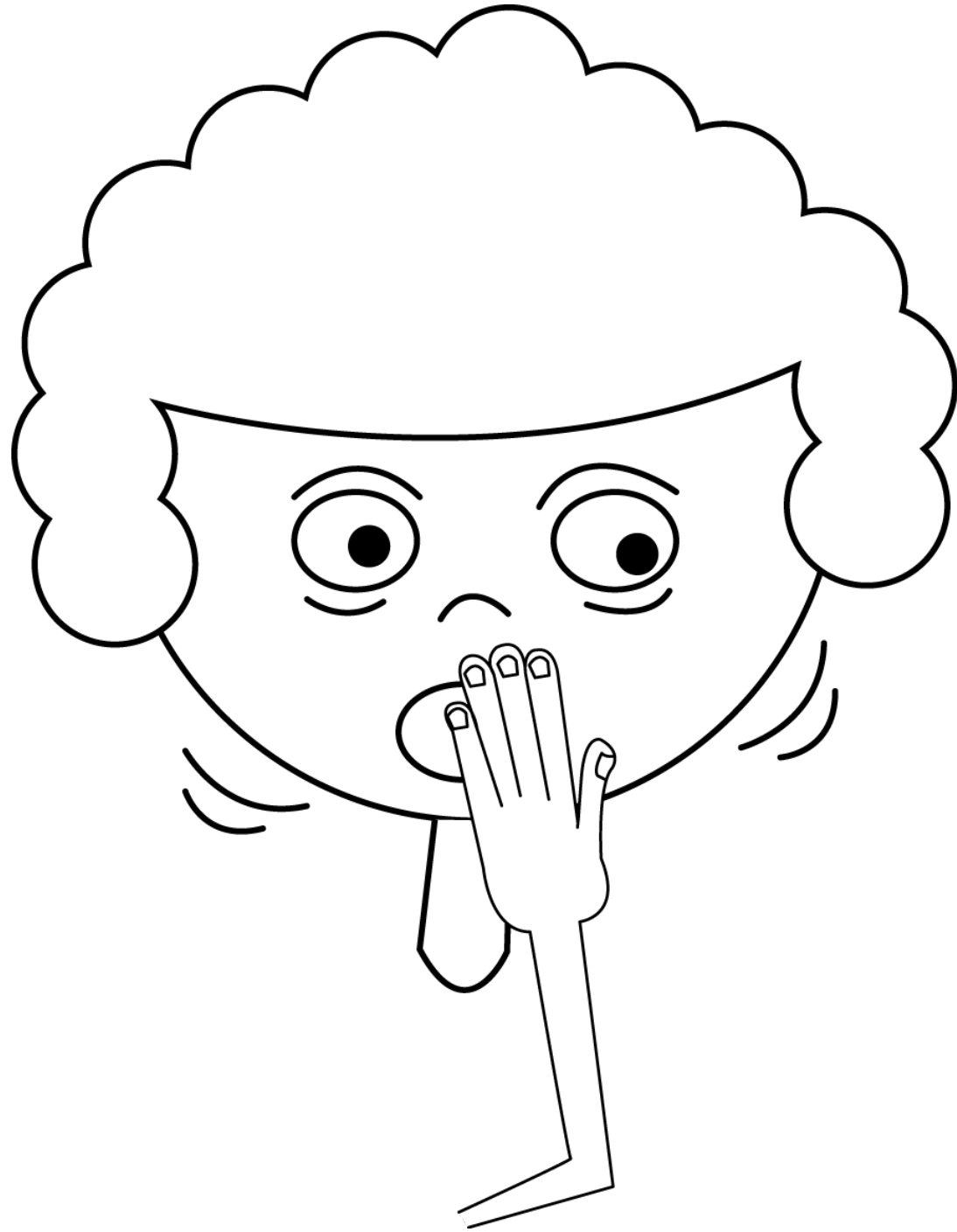

worried

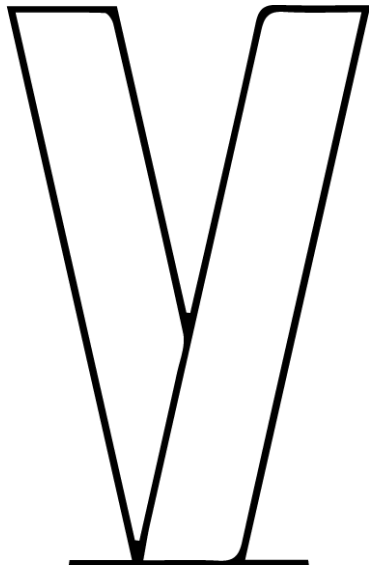

Bongi

name

Peace



Hap-py



Beau-ti-ful



syllable

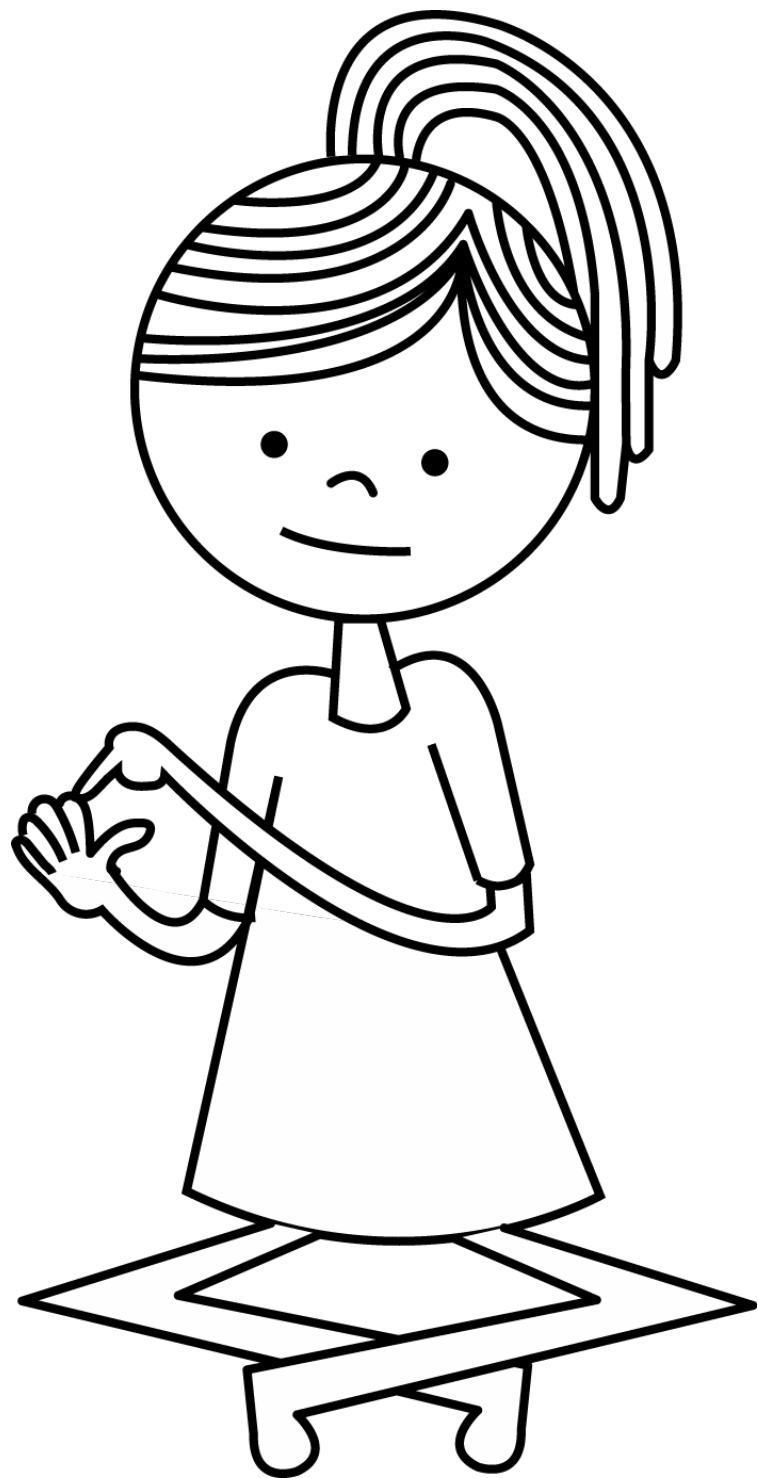

count



clap